

**ENFIELD BOARD OF EDUCATION
ENFIELD, CONNECTICUT**

Agenda

Date: 05/28/13

**Time-Place: Council Chambers
 820 Enfield Street
 Enfield, CT
 7:00 PM Regular Meeting**

- 1. Call to Order – 7:00 PM**
- 2. Executive Session *Note: The Board plans to enter into Executive Session starting from 7:00 PM – 8:00 PM to discuss:***
 - a. Matter(s) Related to Attorney Related & Attorney Client Privilege**
 - b. Matter(s) Related to Personnel**
- 3. Invocation or Moment of Silence – Timothy Neville**
- 4. Pledge of Allegiance – Timothy Neville**
- 5. Fire Evacuation Announcement**
- 6. Roll Call**
- 7. Board Guest(s)**
- 8. Superintendent’s Report**
 - a. Student Representatives & Alternates**
 - b. EHS/FHS Scholarship/Award Nights**
 - c. Enfield Gets Ready for Grade One**
 - d. Grants Report**
 - e. Personnel Report**
- 9. Audiences**
- 10. Unfinished Business**
 - a. Continue FY2013-14 Budget Discussion and Action, if any**
- 11. New Business**
 - a. 2013 Lester J. Bodley Memorial Scholarship**
 - b. Discussion Regarding the Use of the Enrico Fermi Building**
- 12. Board Committee Reports**
- 13. Board Members’ Comments**

- 14. Approval of Minutes: Regular Meeting Minutes – May 14, 2013**
- 15. Approval of Accounts and Payroll**
- 16. Correspondence and Communications**
- 17. Executive Session**
 - a. Matter(s) Related to Collective Bargaining**
 - b. Matter(s) Related to Superintendent's Evaluation**
- 18. Adjournment**



ENFIELD PUBLIC SCHOOLS

27 SHAKER ROAD · ENFIELD, CONNECTICUT 06082
TEL: 860.253.6500 · FAX 860.253.6510 · WWW.ENFIELDSCHOOLS.ORG

Date: May 28, 2013
To: Enfield Board of Education
From: Dr. Jeffrey A. Schumann
Re: Executive Session

The Board of Education needs to discuss the following item:

- Matter(s) Related to Attorney Related & Attorney Client Privilege
- Matter(s) Related to Personnel

Therefore, I recommend that the Enfield Board of Education enter into executive session, with the appropriate personnel invited, for the reasons described above. An affirmative vote of two-thirds of the members present and voting is required. Board members can relocate to either the Thompsonville Room for the executive session.



ENFIELD PUBLIC SCHOOLS

27 SHAKER ROAD · ENFIELD, CONNECTICUT 06082
TEL: 860.253.6500 · FAX 860.253.6510 · WWW.ENFIELDSCHOOLS.ORG

Date: May 28, 2013
To: Enfield Board of Education
From: Dr. Jeffrey A. Schumann
Re: Superintendent's Report

- a. **Student Representatives & Alternates:** Board members will approve the 2013-14 Student Representatives and Alternates to the Board at an upcoming meeting. At this time, I would like to address Board Policy #9160 Student Representatives with the Board.
- b. **EHS/FHS Scholarship/Award Nights:** Both of our high schools will hold scholarship and awards nights. Enfield High will hold their academic awards program on Wednesday, May 29th and their scholarship program on Tuesday, June 4th. Both programs will start at 6:30 PM and will be held in the Auditorium. Enrico Fermi will hold their scholarship/awards night on Monday, June 3rd at 6:30 PM in the Auditorium. If any Board member is planning to attend any or all of these events, please notify my office.
- c. **Enfield Gets Ready for Grade One:** The Enfield Gets Ready for Grade One program will be held on Thursday, June 6th at Henry Barnard Elementary School at 6:30 PM.
- d. **Grants Report:** The Grants Report is enclosed for your review.
- e. **Personnel Report:** the Personnel Report through May 24th is also enclosed for your review.



ENFIELD PUBLIC SCHOOLS

27 SHAKER ROAD · ENFIELD, CONNECTICUT 06082
TEL: 860.253.6500 · FAX 860.253.6510 · WWW.ENFIELDSCHOOLS.ORG

Date: May 28, 2013
To: Enfield Board of Education
From: Dr. Jeffrey A. Schumann
Re: Continue FY2013-14 Budget Discussion and Action, if any

Board members can continue the FY2013-14 Budget discussion at this time and take any action(s) deemed appropriate regarding adopting the FY2013-14 Budget.



ENFIELD PUBLIC SCHOOLS

27 SHAKER ROAD · ENFIELD, CONNECTICUT 06082
TEL: 860.253.6500 · FAX 860.253.6510 · WWW.ENFIELDSCHOOLS.ORG

Date: May 28, 2013
To: Enfield Board of Education
From: Dr. Jeffrey A. Schumann
Re: 2013 Lester J. Bodley Memorial Scholarship

Since 2004, the Enfield Board of Education has announced the recipients of the Lester J. Bodley Memorial Scholarships at a Board meeting. These scholarships are awarded each year to a boy and girl graduate from Enfield High School.

Enclosed in your packet is information provided by Elizabeth Ogonis, Guidance Counselor at Enfield High School. Due to student confidentiality and the timing of their scholarship program, they are recommending that both students be referred as Student A and Student B instead of announcing their names publically.

Therefore, the Enfield Board of Education may take any action(s) deemed appropriate on awarding the 2013 Lester J. Bodley Memorial scholarships for Student A and Student B as presented.



ENFIELD PUBLIC SCHOOLS

27 SHAKER ROAD · ENFIELD, CONNECTICUT 06082
TEL: 860.253.6500 · FAX 860.253.6510 · WWW.ENFIELDSCHOOLS.ORG

Date: May 28, 2013
To: Enfield Board of Education
From: Dr. Jeffrey A. Schumann
Re: Discussion Regarding the Use of the Enrico Fermi Building

Board members requested that this item be placed on the May 28th agenda to start the discussion regarding possible uses for the Enrico Fermi Building. It would be appropriate to start this discussion at this time.



ENFIELD PUBLIC SCHOOLS

27 SHAKER ROAD · ENFIELD, CONNECTICUT 06082
TEL: 860.253.6500 · FAX 860.253.6510 · WWW.ENFIELDSCHOOLS.ORG

Date: May 28, 2013
To: Enfield Board of Education
From: Dr. Jeffrey A. Schumann
Re: Executive Session

The Board of Education needs to discuss the following item:

- Matter(s) Related to Collective Bargaining
- Matter(s) Related to the Superintendent's Evaluation

Therefore, I recommend that the Enfield Board of Education enter into executive session, with the appropriate personnel invited, for the reasons described above. An affirmative vote of two-thirds of the members present and voting is required. Board members can relocate to either the Enfield Room or the Thompsonville Room whichever is available for the executive session.

**ENFIELD BOARD OF EDUCATION
ENFIELD, CONNECTICUT**

STUDENT REPRESENTATIVES

9160

The Enfield Board of Education acknowledges the value of the insights, opinions and information that can be provided by members of the student body. To this end, it will be the policy of The Board to seat one student from Enfield High School and one student from Enrico Fermi High School in nonvoting capacity at all public Board of Education meetings. Student opinion will be solicited to give an added dimension to the Board's decision-making process.

The following guidelines and procedures will be followed for the seating of the student representatives:

1. Student representatives shall attend as a guest and at the invitation of The Board.
2. Attendance at Board meetings shall be considered a school sponsored event and, as such, student representatives shall be subject to and comply with all Board policies as well as all school rules and regulations.
3. One (1) student representative and (1) alternate representative shall be recommended by the student government body, subject to the approval of the building Principal. To be eligible the student must be a member of the Junior or Senior class in good standing (letter grade "C" average or above), cannot be ineligible for student activities and must have taken and passed a Civics course as a pre-requisite.
4. The Board of Education reserves the right to dismiss a student representative, by majority vote, who fails to attend three (3) Board meetings without being excused or other cause and call for the selection of a new representative. Student representatives may also be removed from their position of nonvoting representatives to the Board of Education by action of the building Principal, with input from the faculty advisor(s) of the student governing body.
5. Student representatives shall be recommended and appointed in the spring of the current school year for the following school year, except for the 2004-05 school year, in which case the representatives shall be recommended upon the adoption of the Board policy for the remainder of the 2004-05 school year.
6. The term of office for student representatives shall be one (1) school year, normally beginning with the start of the school year.
7. Student representatives shall receive credit for participation as an Independent Study and shall report back to the student governing body and the teacher assigned as the advisor to the student governing body.

50 8. After being appointed, Student Representatives will be given an orientation
51 session by the Superintendent of Schools, a member of the Board of Education
52 or their designee, the building Principal and a teacher advisor from the student
53 governing body.

54
55 9. **Privileges and Responsibilities:**

56
57 **Student Representatives may:**

- 58
59 1. Be able to attend all regular meetings of the Board of Education and
60 may, at their option, attend special meetings or other public meetings of
61 the Board of Education;
62
63 2. Receive copies of all regular meeting agendas, minutes and other
64 pertinent information and publications which are made available to
65 Board of Education members, except for Executive Session related
66 material;
67
68 3. Comment under Board Comments on the agenda or make a report under
69 Committee Reports;
70
71 4. Request through the Chairman or ranking Minority member to have an
72 item placed on the agenda for a Board meeting;
73
74 5. Participate in discussion and speak on any motion or issue on the
75 agenda unless deemed inappropriate by the Board;
76
77 6. Be eligible to sit on committees and sub-committees of the Board of
78 Education if deemed appropriate by the Board and appointed by the
79 Chairman.

80
81 **Student Representatives may not:**

- 82
83 1. Make motions or cast an official vote on any motion or resolution;
84
85 2. Attend executive sessions, "non-meetings," negotiation sessions or any
86 other meeting deemed inappropriate by the Board.
87

88 Only those privileges and powers enumerated previously shall be regarded specifically
89 as such; any and all other powers and privileges that might be deemed appropriate for
90 the student representatives shall be decided upon by the Board of Education.
91

92
93
94
95
96 **Policy Adopted: November 23, 2004**
97 **Policy Reviewed: October 13, 2009**

**ENFIELD PUBLIC SCHOOLS
FY 2013 GRANTS**

APPROVAL FOR FY2013

	<u>Award</u>	<u>Approval Date</u>	<u>Pending 2014</u>	<u>Date Submitted</u>
Adult Education - (Grant Portion)	\$ 83,676.00	7/12/2012	\$ 99,080.00	4/15/2013
Adult Education - Cooperative	\$ 53,929.00	7/12/2012	\$ 58,186.00	4/15/2013
Adult Ed - Literacy Volunteers	\$ 13,430.00	7/12/2012	\$ 13,681.00	4/15/2013
Adult Education Program Improvement Project	\$ 70,000.00	8/22/2012	\$ 70,000.00	5/14/2013
Perkins	\$ 61,315.00	10/9/2012	\$ 61,315.00	intent applied
Head Start State Grants (Enhancement, Extended Services, Early Link)	\$ 123,872.00	8/6/2012	\$ 134,975.00	4/9/2013
* Head Start Federal Grants (FY 3/1/13 - 2/28/14)	\$ 771,481.00	reduced by 5.2%		
JFK After School Program	\$ 111,688.00	12/21/2012		
IDEA Section 611, Special Education Assistance FY12	\$ 12,823.00	10/2/2012		
IDEA Section 611, Special Education Assistance FY13	\$ 1,269,166.00	10/3/2012	\$ 1,269,166.00	5/3/2013
IDEA Section 619, Preschool Education	\$ 52,385.00	10/3/2012	\$ 52,385.00	5/3/2013
Parent Leadership (year 2)	\$ 19,784.00	8/17/2012		
Title I	\$ 711,880.00	12/12/2012		
Title II	\$ 134,451.00	12/12/2012		
Title III	\$ 15,015.00	12/12/2012		
Sheff Open Choice	\$ 53,775.00	11/9/2012		
Open Choice	\$ 50,165.00	2/1/2013		
Open Choice Early Beginnings	\$ 36,000.00	10/1/2012		
TOTAL	\$ 3,644,835.00		\$ 1,758,788.00	

Item # 8d.

Notes:

* All FY2014 grant applications are pending. We have been notified by the State to expect decreases of 5 - 8% next year.

Item # 8e.

CERTIFIED PERSONNEL MATTERS
April 22, 2013 through May 24, 2013

-NONE-

NON-CERTIFIED PERSONNEL MATTERS
April 22, 2013 through May 24, 2013

-NONE-

Item # 10a.

**ENFIELD TOWN COUNCIL
RESOLUTION NO. _____**

RESOLVED, that the Town Schools' Budget adopted by the Town Council in the amount of \$64,262,157 included the anticipated revenue of \$29,931,293 from the Education Block (Cost Sharing) Grant, on page 26 of the 2013-2014 Annual Operating and Capital Budget

Date Prepared: May 13, 2013
Prepared by: Finance and Town Manager

**ENFIELD TOWN COUNCIL
RESOLUTION NO. _____**

RESOLVED, that page 25, General Fund Revenue Summary and page 31, Summary of Expenditure of the Town Budget, as submitted by the Town Manager and the estimates for the fiscal year commencing July 1, 2013 and ending June 30, 2014 including estimates of receipts and expenditures and recommendations of said Town of Enfield for:

Emergency Medical Services (pgs. 124, 126-129);
Water Pollution Control (pgs. 132, 134-137);
Social Services Fund (pgs. 143, 148);
Dog Fund (pgs. 183-184);
Information Technology Fund (pgs. 188, 190-192);
Recreation Fund (pgs. 196, 199-206)
Insurance Fund (pgs. 208-214); and
Capital Improvement funds (pgs. 217-218)

be accepted and approved by the Town Council of the Town of Enfield.

BE IT FURTHER RESOLVED, that any and all monies deemed by the Enfield Director of Finance saved by the Enfield Board of Education, unspent and unencumbered, in its Fiscal Year 2013 General Fund Allotment be appropriated to the Information Technology Fund at the date of earliest action by the Enfield Town Council in order to offset the required FY 2014 Enfield Board of Education's contribution.

Date Prepared: May 13, 2013
Prepared by: Finance and Town Manager

Guidance Department

Tel: (860) 253-5550
(860) 253-6595
Fax: (860) 253-5326



Guidance Counselors

Mrs. Joy DiMaggio, Chairperson
Ms. Karen Gustafson
Ms. Elizabeth Ogonis
Mrs. Ellen Frost

May 15, 2013

Dear Dr. Schumann & the Board of Education,

In May of 2004, Enfield High School was notified that a very generous man, Lester J. Bodley, had passed away. In his will he left a fund of \$200,000 to be used for scholarships for graduates of Enfield High School. The will stipulates that the scholarship winners must be selected by a committee at the school and approved by the "school committee". In Enfield, that is our Board of Education. The monies must come from the interest rather than the principal. Unfortunately, as interest rates have dropped so have the awards. We awarded these scholarships for the first time in 2004. Those awards were \$1500. each. This year, the awards have increased to \$250 each.

An interesting aside about Mr. Bodley is that we have been unable to learn much about him. My letters to the bank that handled the trust and internet searches have resulted in very little information. He did attend Enfield High School, worked for the Bigelow Carpet Mills as a salesman and permanently relocated down south after the sudden death of his fiancée. We cannot even verify that he was a graduate of Enfield High.

Enclosed you will find the two students' applications for the Lester J. Bodley awards. Our committee comprised of teachers, counselors and administrators felt that Student A and Student B were the two deserving students who best exemplified the stipulations of the will. Both students are very well rounded and have demonstrated leadership and involvement within Enfield High School and the community. They also have some financial need for college. Student A will be attending Georgetown University. Student B will be attending Drexel University.

Thank you for considering these two fine students for this scholarship. I look forward to hearing from you regarding their confirmation as Bodley recipients. Please do not hesitate to contact me if you or the BOE members have any concerns or questions.

You are all cordially invited to attend our Scholarship Program on June 4, 2013 at 6:30 P.M. in the Enfield High School auditorium.

Most sincerely,

Elizabeth J. Ogonis

Item #11b.

Enrico Fermi High School

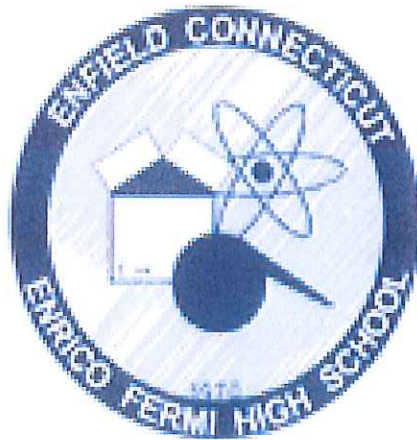

ADA Compliance Action Plan

DRAFT

9 December 2010



MAIER design group, llc.

architecture & interiors

**ENRICO FERMI HIGH SCHOOL
ADA COMPLIANCE ACTION PLAN**

EXECUTIVE SUMMARY

PROCESS

Maier Design Group was asked to review the existing conditions at the Enrico Fermi High School in order to determine the magnitude of work required to modify the building to address the issues noted in the State Department of Education, Bureau of School Facilities Inspection Checklist dated 11-1-2006. We toured the building multiple times and conducted a visual inspection of the facilities; we also reviewed existing building drawings. This study reflects only modifications we feel are necessary to adapt the physical building for accessibility and ADA compliance. We have not addressed equipment, staffing or other non-physical defects.

This report contains two parts, an executive summary and an appendix of tagged drawings and diagrams indicating the types of issues that we encountered during our field inspection and proposed remedies.

REQUIRED MODIFICATIONS

Enrico Fermi High School is a 3 story, 215,833 SF building originally designed in 1968. The school has 83 teaching spaces including classrooms and labs. The school also has approximately 8,400 SF of library space distributed among 3 floors and 1,692 student lockers. Additional spaces include a 9,200 SF auditorium seating 586 people, a 10,262 SF cafeteria seating 482 people, a 5,900 SF kitchen, an 11,600 SF gymnasium, a 40FT x 80FT indoor swimming pool and a planetarium.

The plan is relatively compact with 4 wings (Units "A", "B", "C", and "D") off a central core. Unit "A" is 3 stories and contains the library, 3 lecture rooms and classrooms. The single student use elevator is located in Unit "A". The elevator is outdated and requires a full update on controls to improve accessibility. The car size is substandard and does not meet the minimum dimensions for a new accessible elevator. However there is an allowable exception to the dimensional requirements for an existing cab that is met. Pull distance clearances at doors and doorway widths are consistently sub-standard throughout Unit "A" and need to be modified as indicated elsewhere in this report. Door hardware is also consistently non-compliant and all knob sets must be replaced with lever handle locksets.

Unit "B" is 2 stories and contains vocational areas on the lower level and science labs on the upper (ground floor) level. Unit "B" also contains the defunct planetarium and

an unused greenhouse. None of the lab millwork is accessible and each classroom will need to have a minimum of one accessible student station added. Additionally, teacher's benches need to have gas cocks moved to the forward edge of the bench and the valve assemblies can be no more than 48" above the finish floor. Finally, a supplemental work surface would need to be added to each teacher's station at 34" above finish floor.

Unit "C" contains the swimming pool, gymnasium and locker rooms to serve them. The central core of Unit "C" is 3 stories with locker rooms on all 3 levels. Currently only the locker rooms on the middle (ground floor) level of Unit "C" are accessible to individuals with mobility impairments. Five percent of the lockers in each of the two locker rooms on the main level shall be made accessible, the remaining locker rooms may remain unaltered and off the accessible route in accordance with 2004 ADAAG Section 222.1, Exception. The swimming pool is lacking one of two means of accessible entry, two vertical lifts are required at opposite ends of the pool. In accordance with 2004 ADAAG Advisory 242.2, those two means are only *recommended* to be different, thus two lifts would comply with the regulations.

Unit "D" is single story and contains the administrative offices along with regular classrooms and the home economics areas. The administrative office require minor interior alterations to provide an accessible route throughout the area.

Unit "E" is the central core of the school and contains the auditorium and music functions on the upper (ground floor) level and the cafeteria and kitchen on the lower level. The lower level of Unit "E" does not align with the lower level of Unit "A" and there are 2 ramps that accommodate the change in elevation. The upper ramp in the lower level is compliant with a measured slope of 1:12. The lower two ramps are slightly too steep and need to be extended slightly to decrease the pitch to a maximum of 1:12 as depicted in the attached drawings and diagrams. The auditorium orchestra pit must be in-filled with new construction to eliminate the drop-off or, alternately, a vertical wheelchair lift could be installed to provide access to the pit. Finally, a minimum of 3 wheelchair spaces need to be provided in the auditorium. We are proposing to create two separate seating areas along the top edge of the auditorium to comply with the horizontal diversity requirements. Vertical diversity is not readily achievable due to the existing slope of the auditorium floor.

ADDITIONAL AREAS OF CONCERN

One point of concern was the scoring booth at the football fields. In scoping for ADA compliance, Section 203.10 Raised Refereeing, Judging, and Scoring Areas from the 2004 ADAAG, "Raised structures used solely for refereeing, judging, or scoring a sport shall not be required to comply with these requirements or to be on an accessible route."

ADA compliant signage is typically lacking throughout the building and each room and space must be provided with Contracted Grade 2 Braille signage.

The building is lacking a fire alarm system throughout. This is a building code issue, not an accessibility requirement. The limited system that is in place does not comply with standards for audible and visual notification to occupants and should be removed in its entirety and replaced with a new, NFPA 72 compliant alarm system except that the maximum allowable sound level of audible notification appliances complying with section 4-3.2.1 of NFPA 72 (1999 edition) shall have a sound level no more than 110 dB at the minimum hearing distance from the audible appliance.

**ENRICO FERMI HIGH SCHOOL
ADA COMPLIANCE ACTION PLAN**

NUMBERED NOTES

1. Replace existing cylinder knob set with ANSI Grade 1 Heavy Duty cylindrical lockset with lever handle that returns to within 1/4" of door face. Lockset function shall match existing except at classrooms where lockset function shall be ANSI F84. The majority of doors are 1-3/4" thick; verify door thickness in the field.
2. Replace existing door closer with surface mounted, heavy duty ADA compliant, adjustable delay action closer. Match existing arm style and mounting location.
3. Door opening does not have adequate pull side clearance. Refer to Detail Plans for required reconfiguration of door area layout.
4. Door opening does not have adequate pull side clearance. Install heavy duty surface mounted automatic door operator with manual push button activators on either side of door. Door shall also be retrofitted with a fail-safe electric strike tied into the door operator.
5. Remove existing under sized door and frame and replace with new 3'-0" wide by 7'-0" high by 1-3/4" thick solid core wood door to match existing with 18ga painted hollow metal frame. Provide new hardware including ANSI Grade 1 Heavy Duty cylindrical lockset with level handle that returns to within 1/4" of door face and three (3) heavy duty ball bearing hinges. Other hardware shall be new to match existing removed hardware. Lockset function shall match existing except at classrooms where lockset function shall be ANSI F84.
6. Remove existing undersized pair of door leafs and replace with unequal width pair of doors with one 3'-0" wide leaf and one narrower leaf to fill in remainder of opening (typically 2'-0" to 2'-6"). Reuse existing hinge points but replace hinges with new heavy duty ball bearing type hinges. Replace closers with new heavy duty ADA compliant adjustable delay action closers. Balance of hardware shall be new to match existing.
7. Provide call-to-assistance telephone at all Area of Refuge locations.
8. Provide directional signage to indicate location of nearest accessible restroom facilities.
9. Remove one urinal and reinstall so rim is 14" AFF maximum.
10. Install 18" long vertical grab bar at side location. See Detail Plans for location, Grab Bar No. GB-?.
11. Install swing-down grab bar on rear wall behind toilet. Detail Plans for location, Grab Bar No. GB-?.

12. Re-set countertop at sink so that the sink rim is 2'-10" maximum AFF. Modify fascia as necessary to provide a minimum of 2-3" knee clearance at sink. Where necessary, modify adjacent base cabinet to provide 2'-6" minimum clear wide clear space at sink. Install TrueBro or equal rigid, PVC coated pipe insulation over all exposed waste and supply lines feeding sink.
13. Modify fascia as necessary to provide a minimum of 2-3" knee clearance at sink. Where necessary, modify adjacent base cabinet to provide 2'-6" minimum clear wide clear space at accessible station. Remove all shelving and obstructions from under sink location.
14. Extend all emergency shower pull chains to be within 48" of finish floor.
15. Modify base cabinet to lower fume hood counter elevation to 2'-10" AFF maximum. Modify fume hood controls so that all controls are duplicated and mounted to the face of the counter adjacent to the accessible hood.
16. Modify gas cocks at accessible workstations so that the valve handle is 44" AFF maximum and within 24" of the face of the counters.
17. Remove failed overlay VCT flooring complete including failed plywood underlayment. Remove existing sub-surface flooring (assumed to be Asbestos Containing Material ACM). Install new flooring over existing prepared structural slab.
18. Modernize elevator controls and call buttons to provide accessible height buttons and audible indicators.
19. Remove existing undersized pair of door leafs and frame and replace with new pair of doors with two 3'-0" wide leaves and HM frame. Provide new heavy duty ball bearing type hinges and heavy duty ADA compliant adjustable delay action closers. Balance of hardware shall be new to match existing.
20. Remove existing ramp and replace with new ADA compliant ramp with 1:12 maximum slope. Provide new 1 ½" diameter steel pipe handrail at 3'-0" AFF extending 1'-0" past top and bottom of ramp, typical both sides.

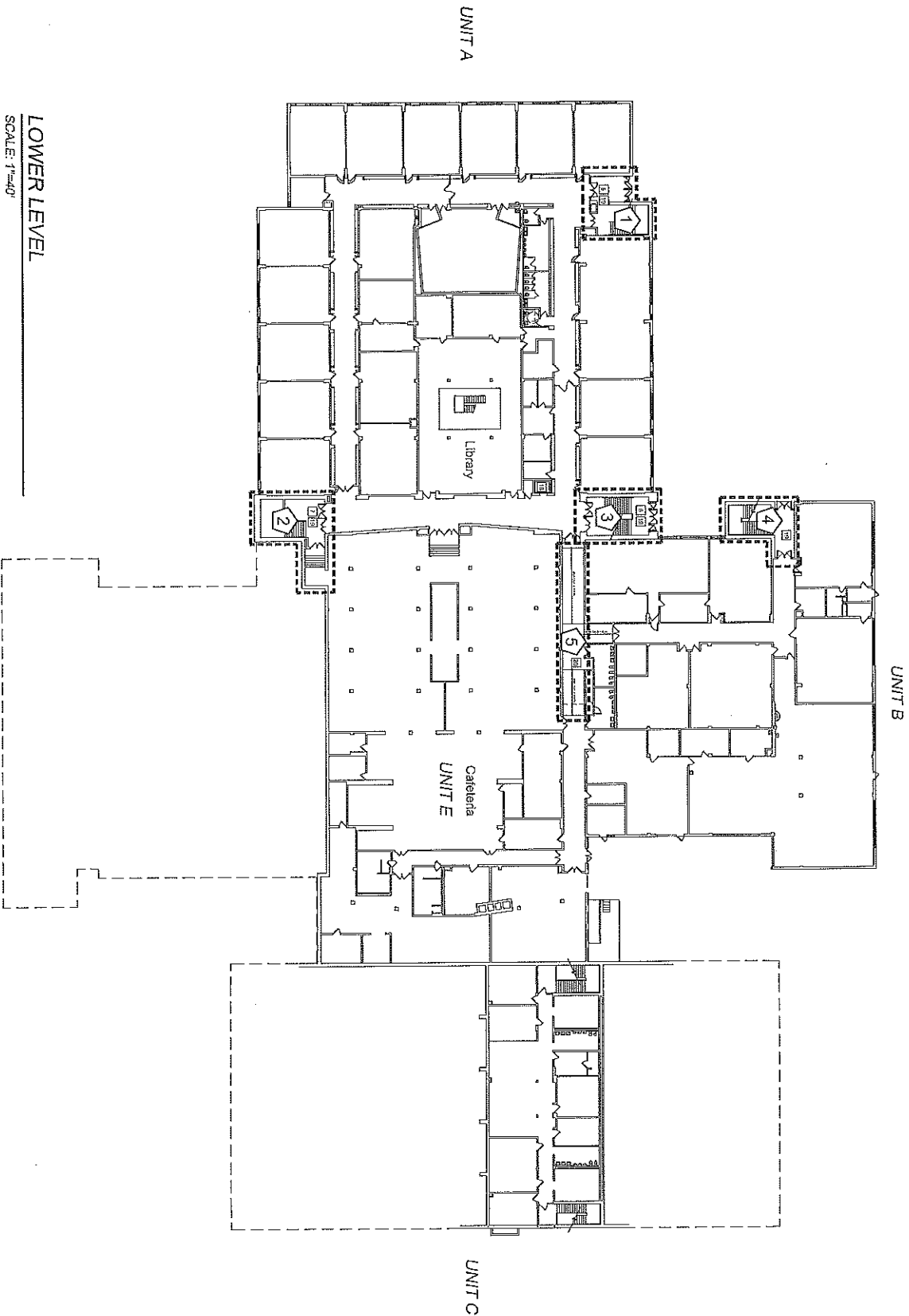

LOWER LEVEL
SCALE: 1"=40'

ENRICO FERMI HIGH SCHOOL - LOWER LEVEL	MDG - 2010.034 12/9/2010
TOWN OF ENFIELD - ADA COMPLIANCE PLAN	LL

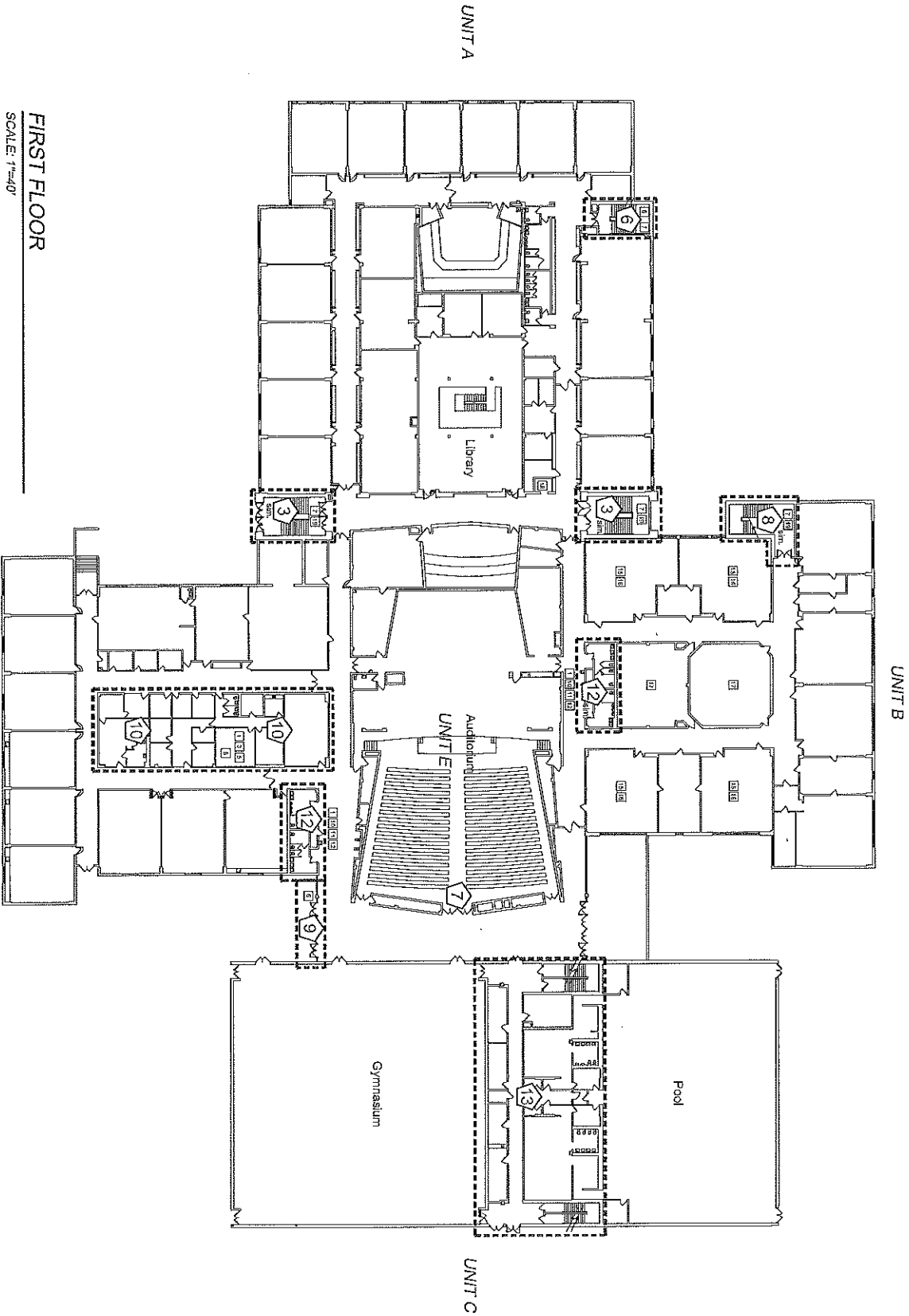

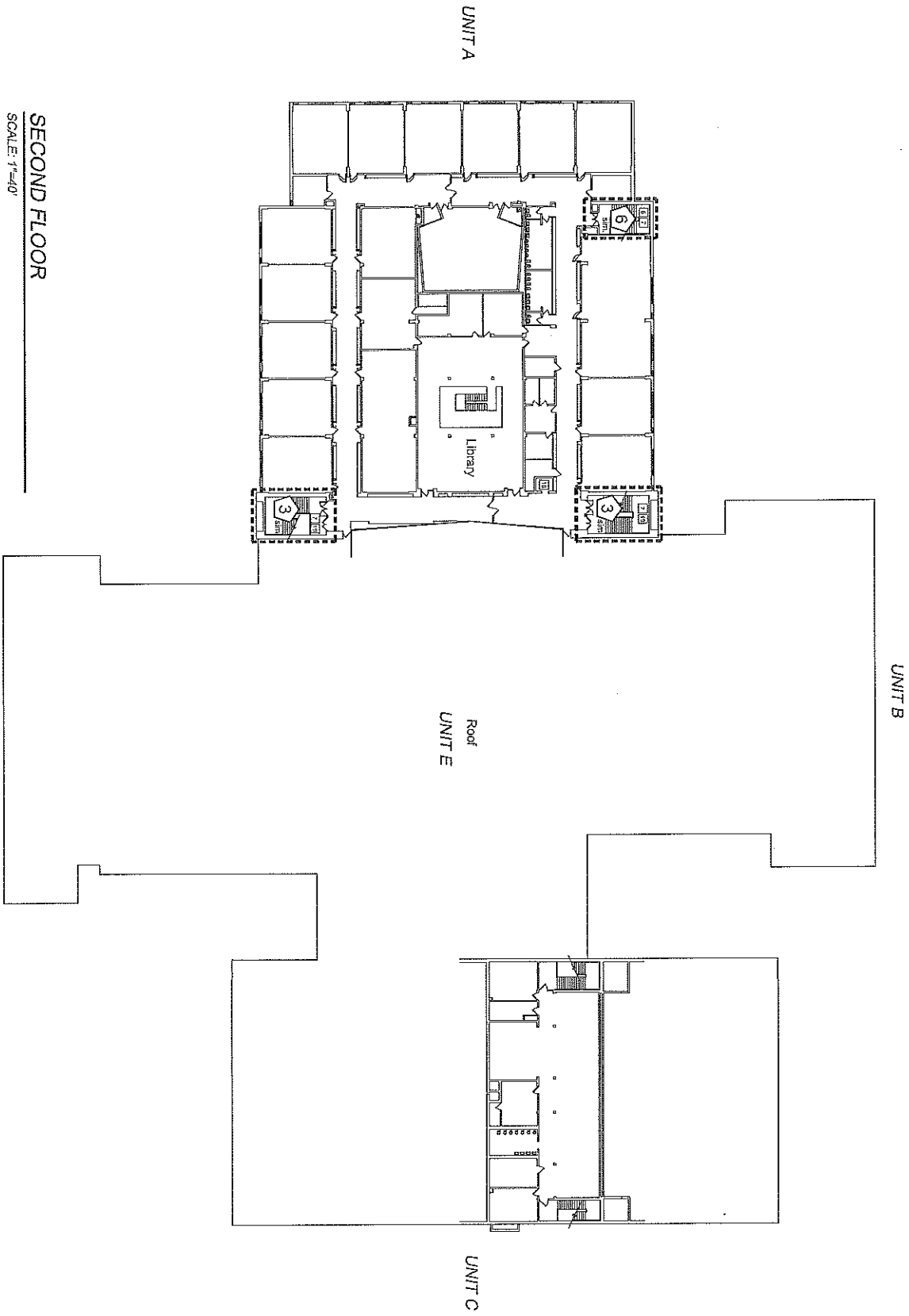

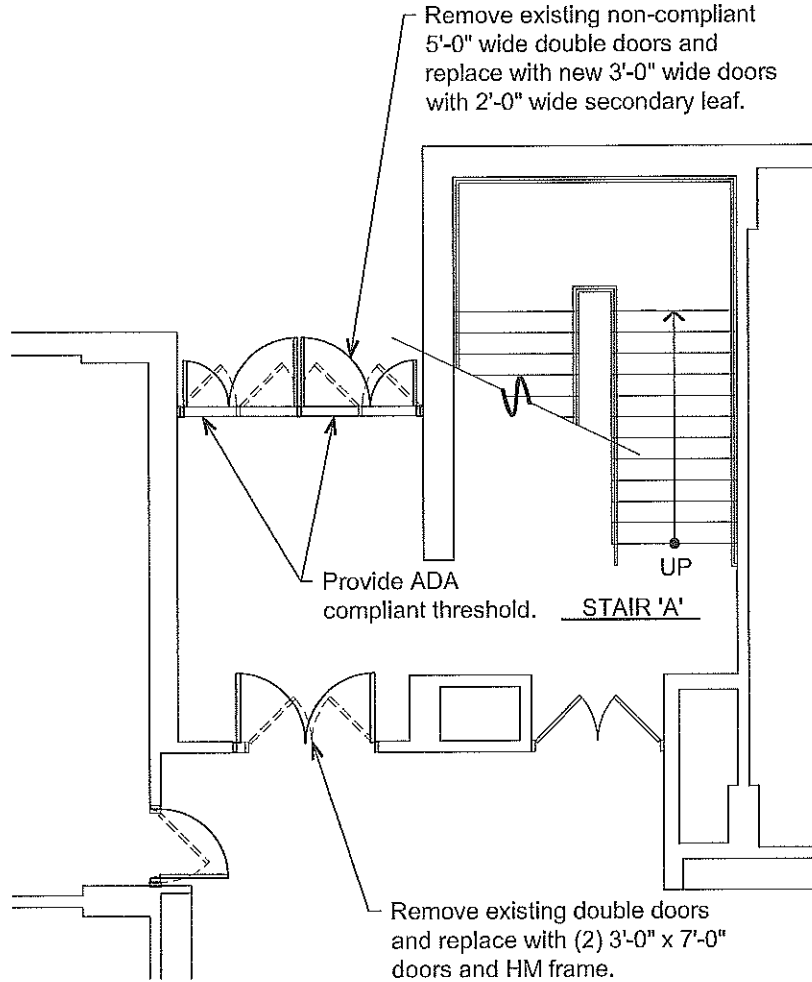

EFHS - LOWER LEVEL STAIR A	MDG - 2010.034 12/9/2010
TOWN OF ENFIELD - ADA COMPLIANCE PLAN	1

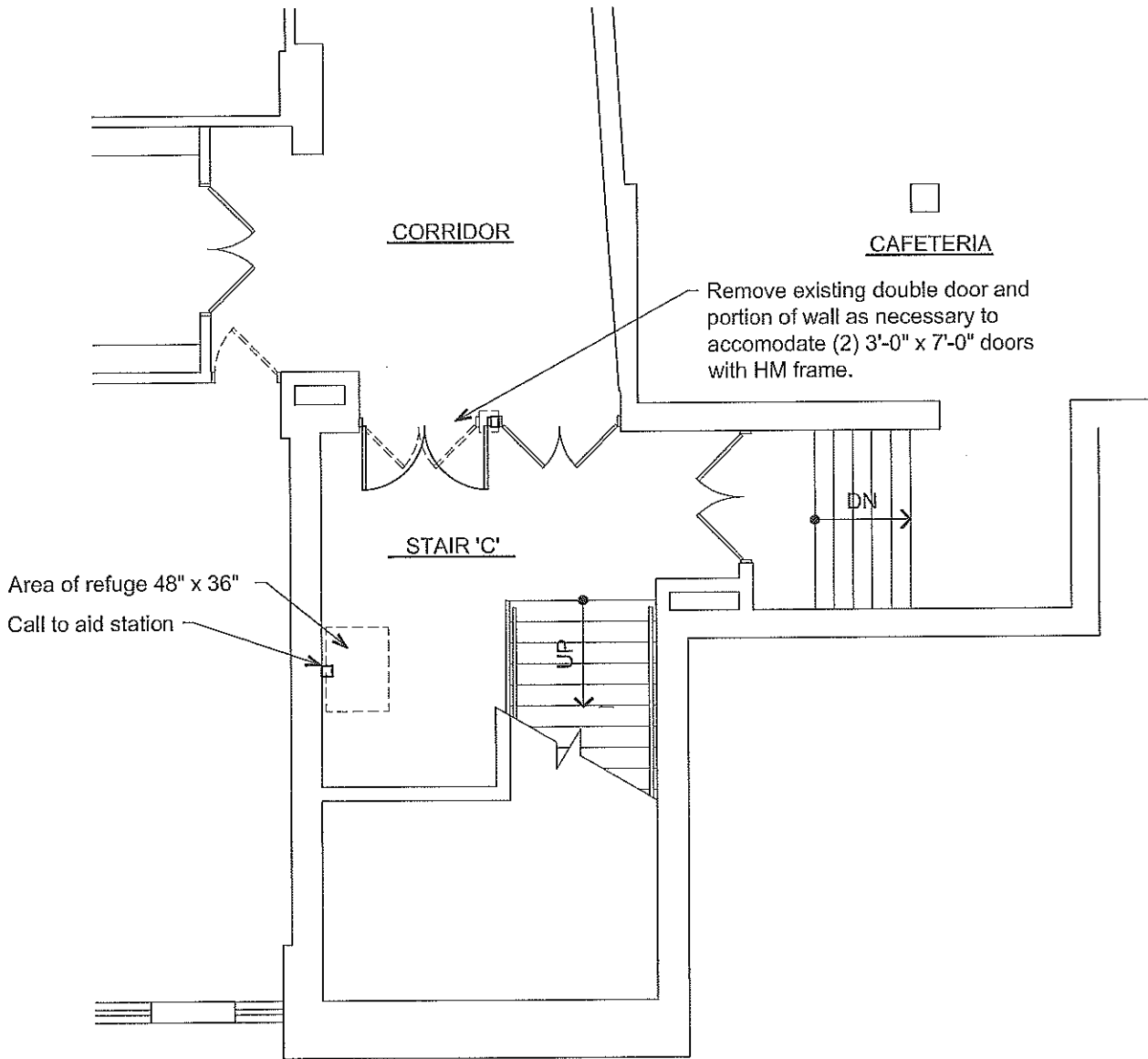

EFHS - LOWER LEVEL STAIR C	MDG - 2010.034 12/9/2010
TOWN OF ENFIELD - ADA COMPLIANCE PLAN	2

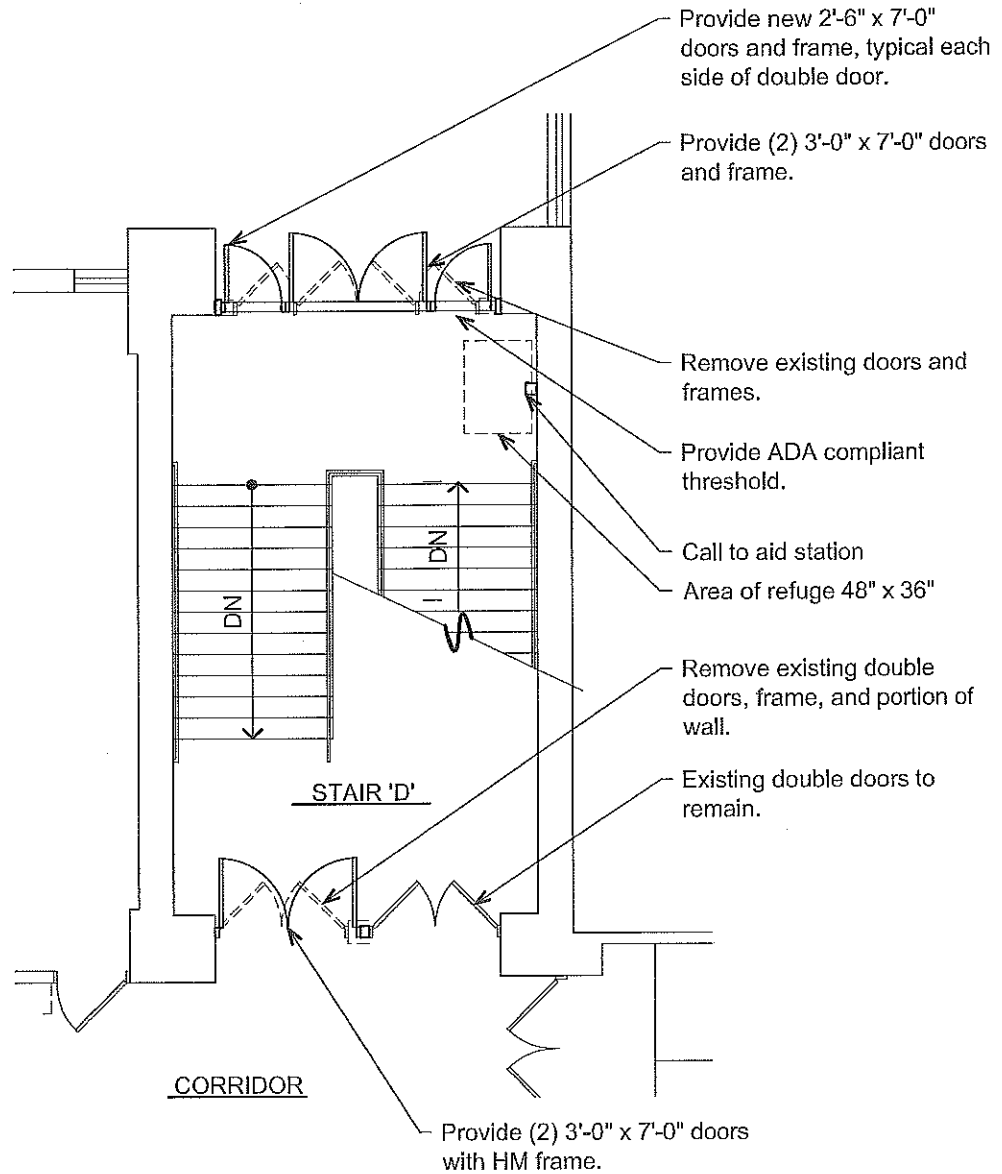

EFHS - LOWER LEVEL STAIR D	MDG - 2010.034 12/9/2010
TOWN OF ENFIELD - ADA COMPLIANCE PLAN	3

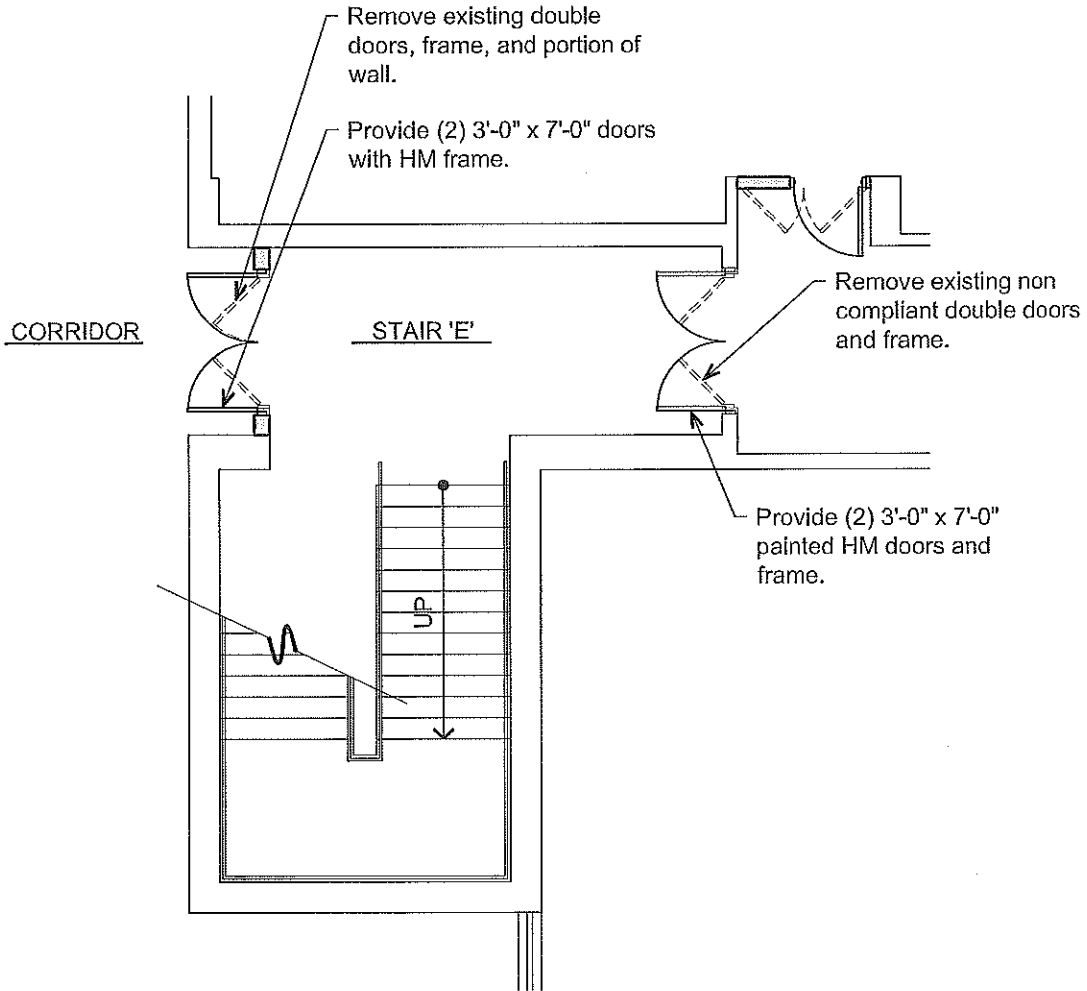

EFHS - LOWER LEVEL STAIR E	MDG - 2010.034 12/9/2010
TOWN OF ENFIELD - ADA COMPLIANCE PLAN	4

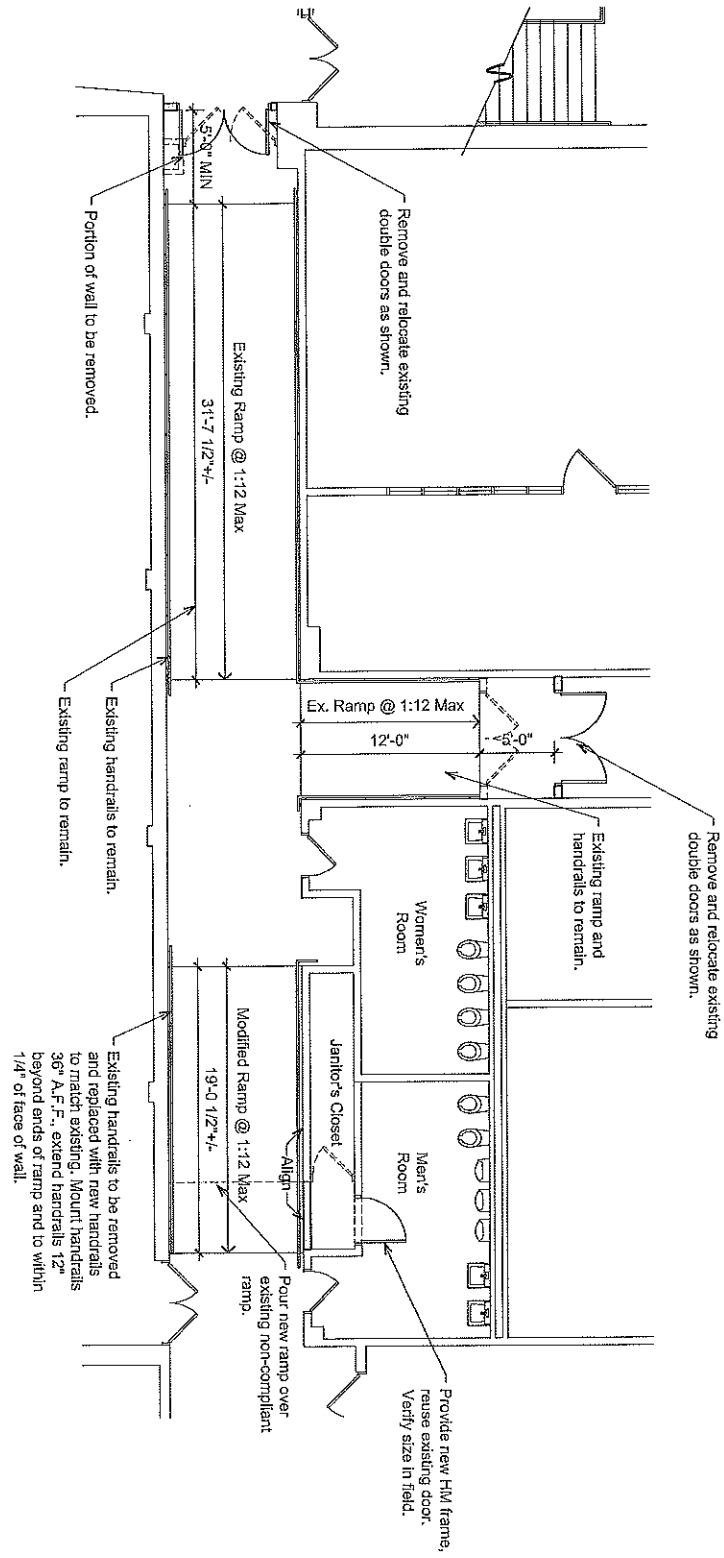

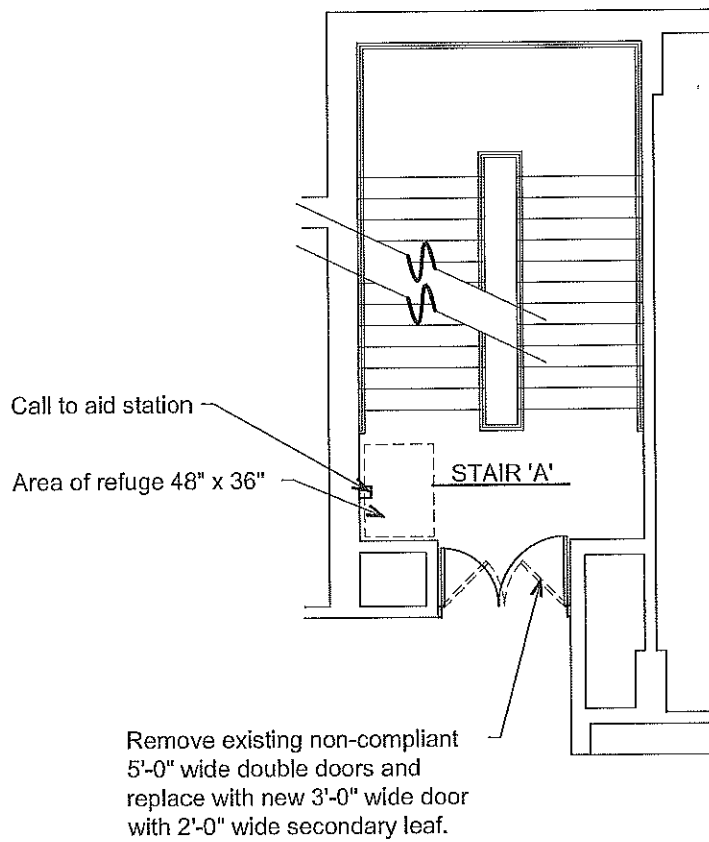

EFHS - FIRST FLOOR STAIR A	MDG - 2010.034 12/9/2010
TOWN OF ENFIELD - ADA COMPLIANCE PLAN	6

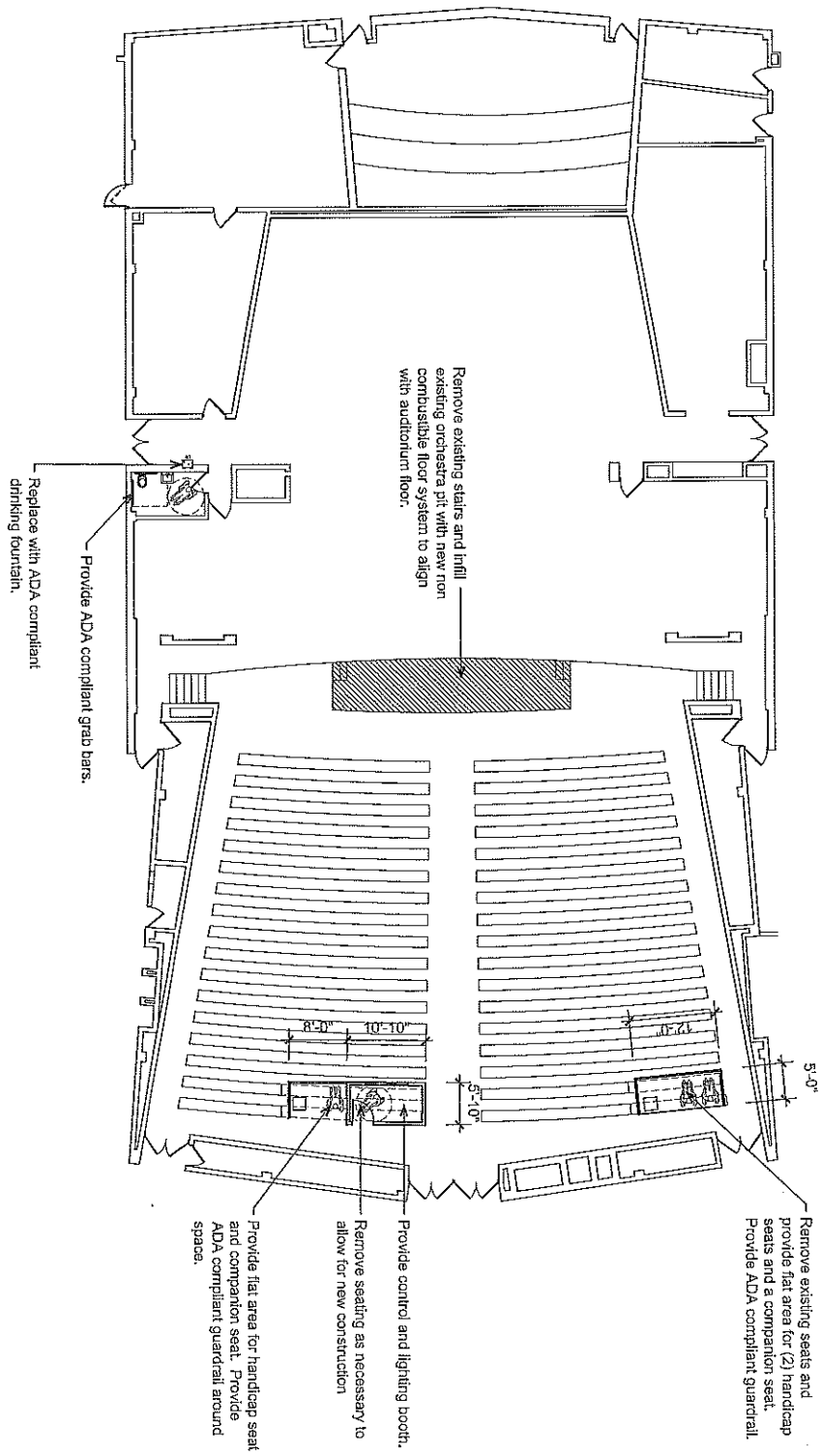

<p>EFHS - FIRST FLOOR AUDITORIUM</p>	<p>MDG - 2010.034 12/9/2010</p>
<p>TOWN OF ENFIELD - ADA COMPLIANCE PLAN</p>	
<p>7</p>	

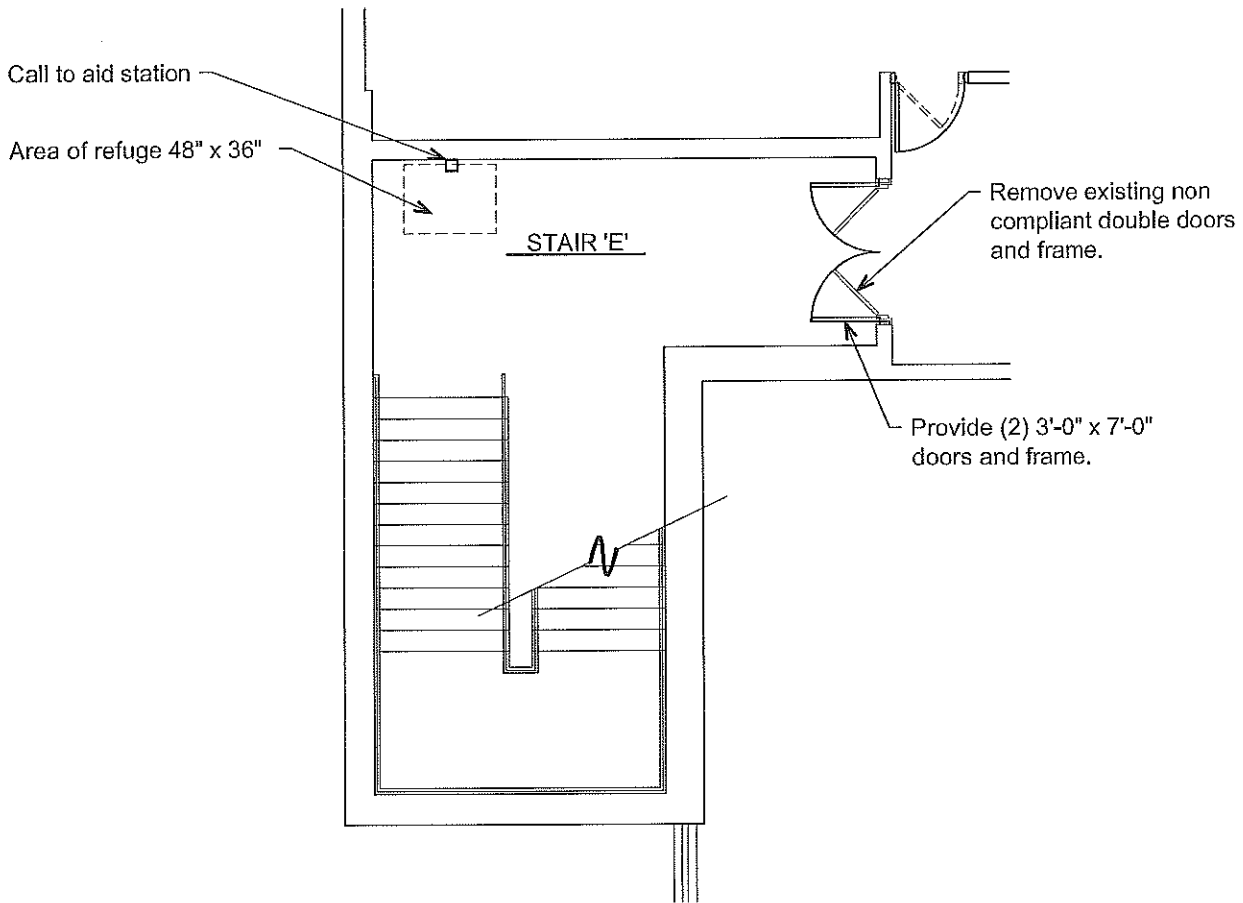

EFHS - FIRST FLOOR STAIR E	MDG - 2010.034 12/9/2010
TOWN OF ENFIELD - ADA COMPLIANCE PLAN	8



CORRIDOR

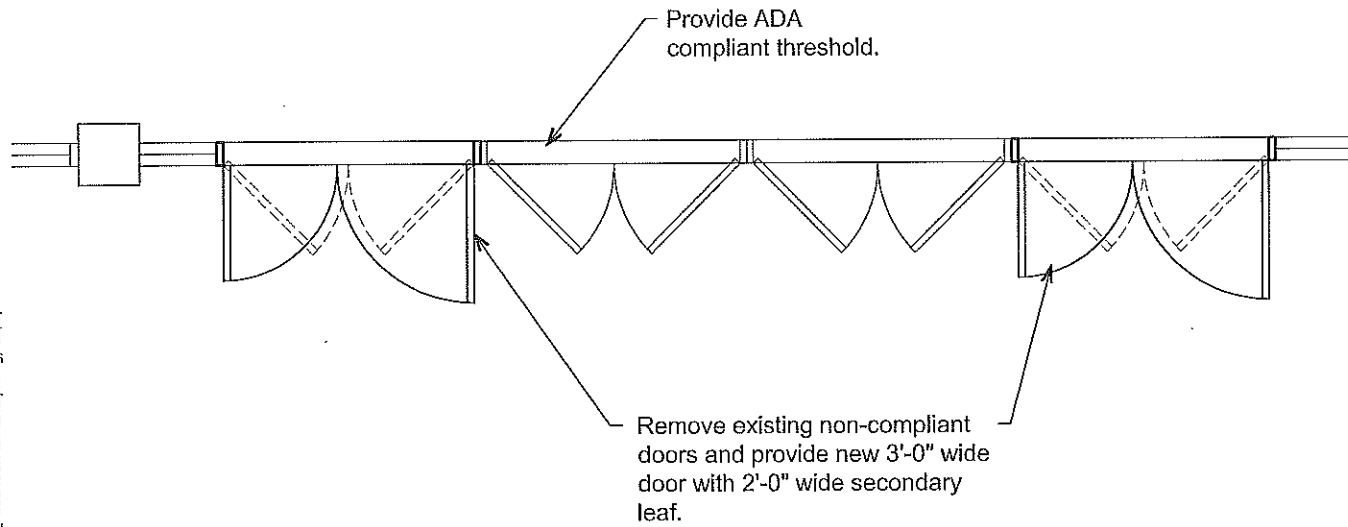

EFHS - FIRST FLOOR MAIN ENTRY	MDG - 2010.034 12/9/2010
TOWN OF ENFIELD - ADA COMPLIANCE PLAN	9

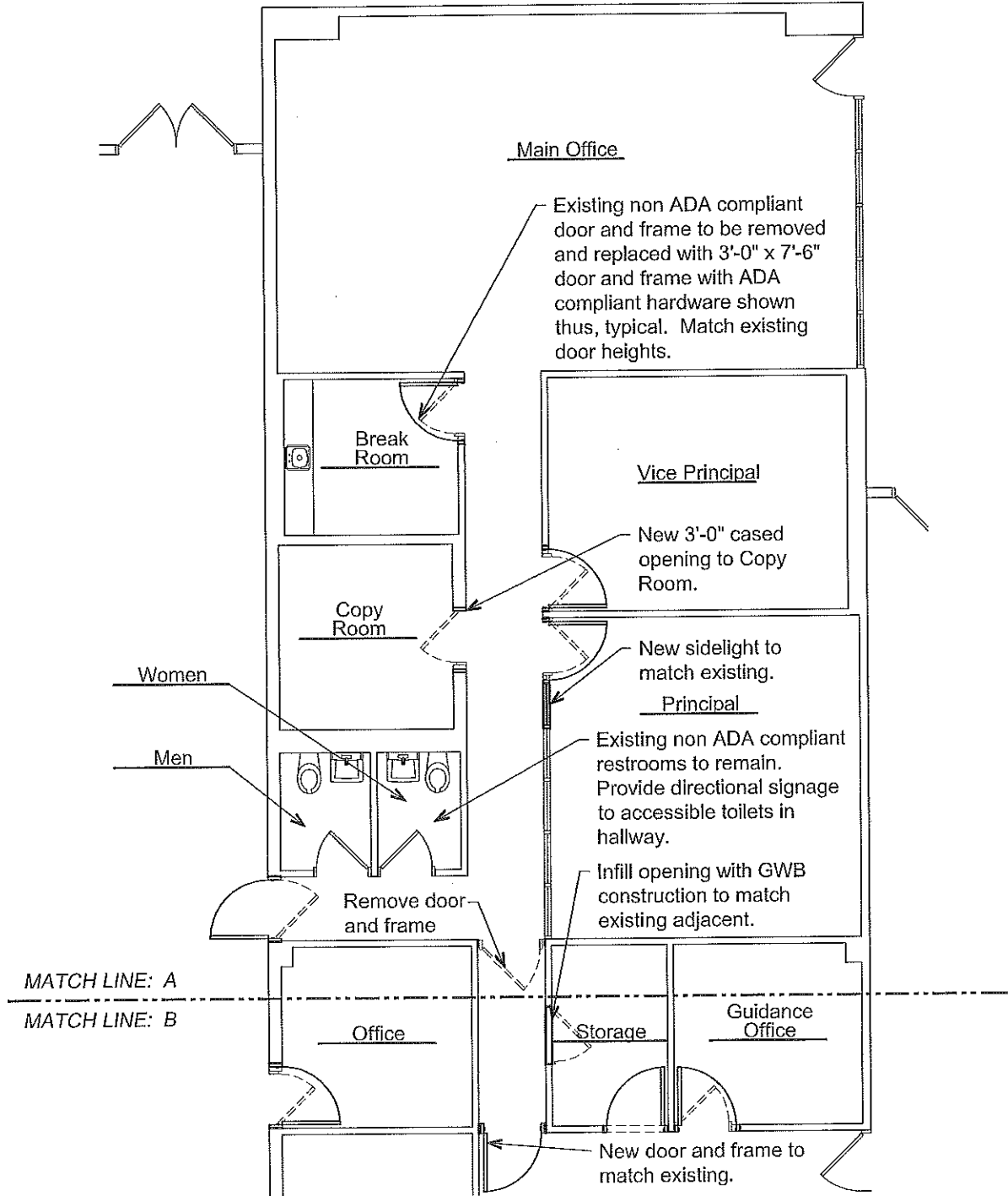

EFHS - ADMINSTRATIVE OFFICES PART A	MDG - 2010.034 12/9/2010
TOWN OF ENFIELD - ADA COMPLIANCE PLAN	10

M:\2010\2010-034_Enfield Enrico Fermi HS ADA Compliance\REPORT\10034_Administration_PLAN.dwg, 12/9/2010 10:49:04 AM

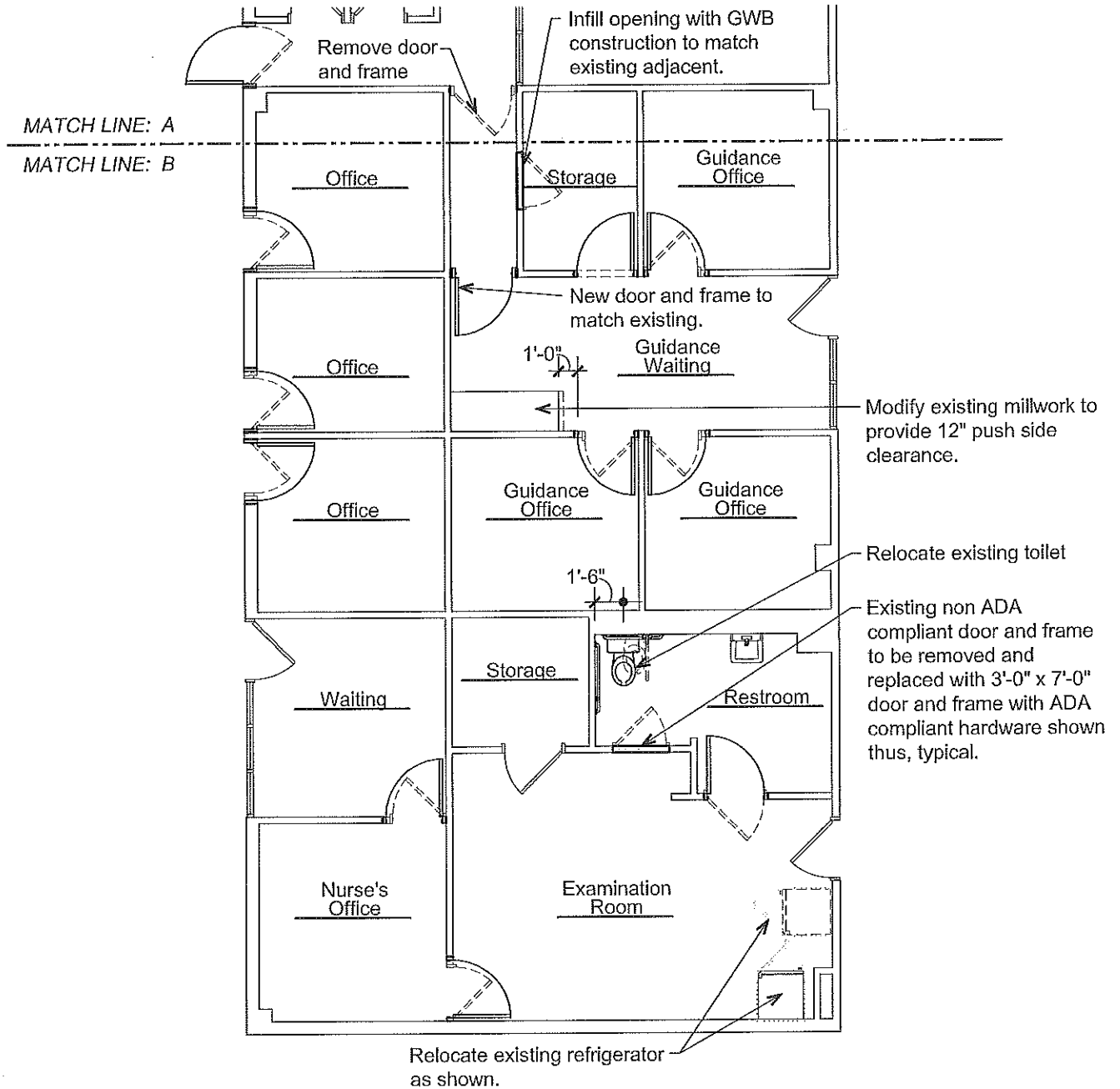

EFHS - ADMINSTRATIVE OFFICES PART B	MDG - 2010.034 12/9/2010
TOWN OF ENFIELD - ADA COMPLIANCE PLAN	11

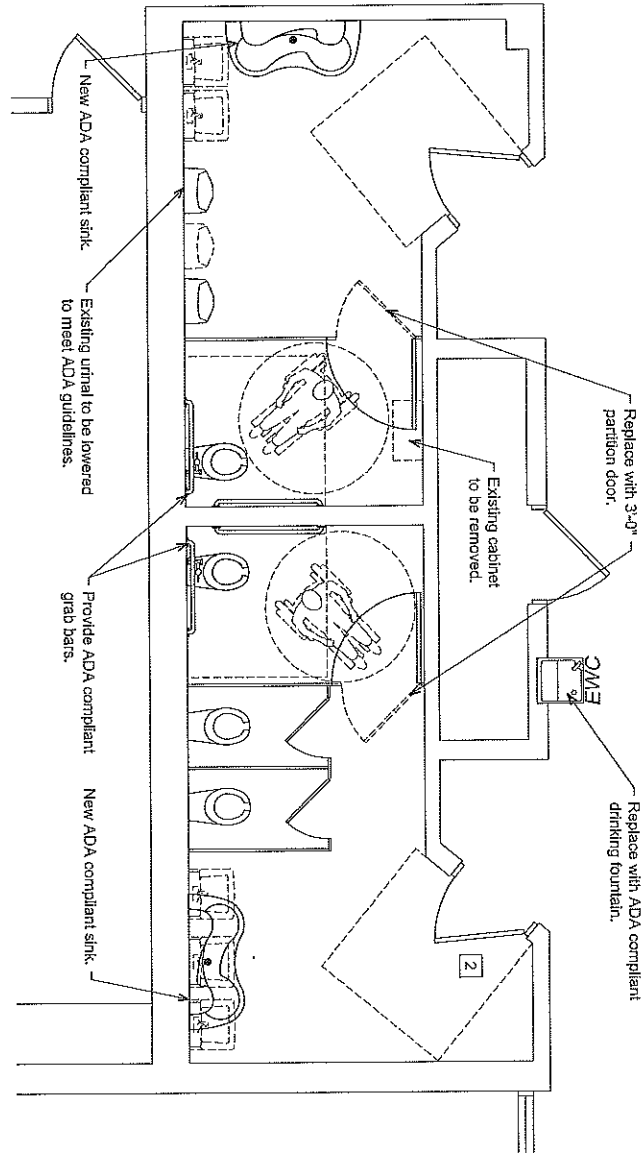

ENRICO FERMI HIGH SCHOOL - FIRST FLOOR RESTROOMS TOWN OF ENFIELD - ADA COMPLIANCE PLAN	MDG - 2010.034 12/9/2010
	12

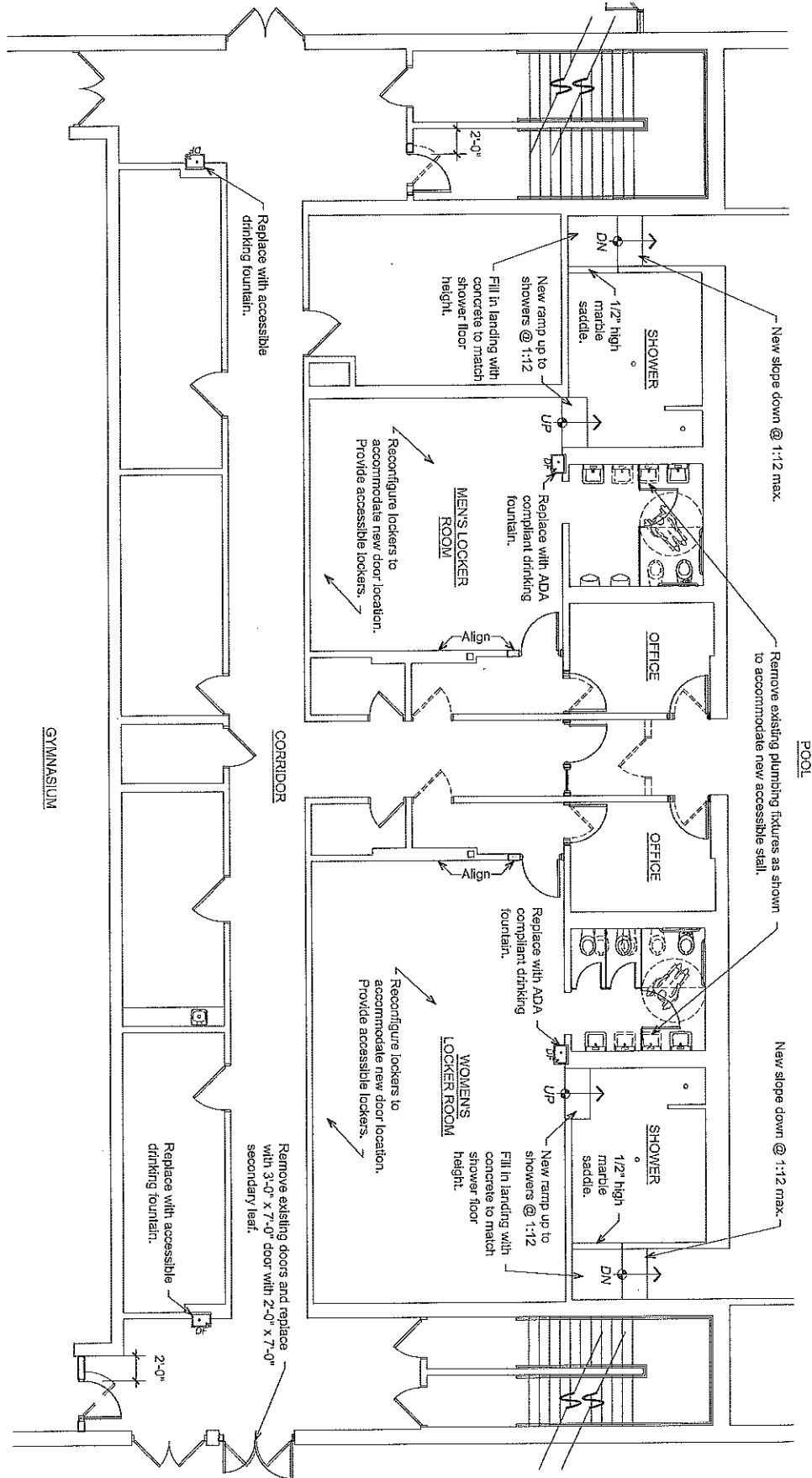

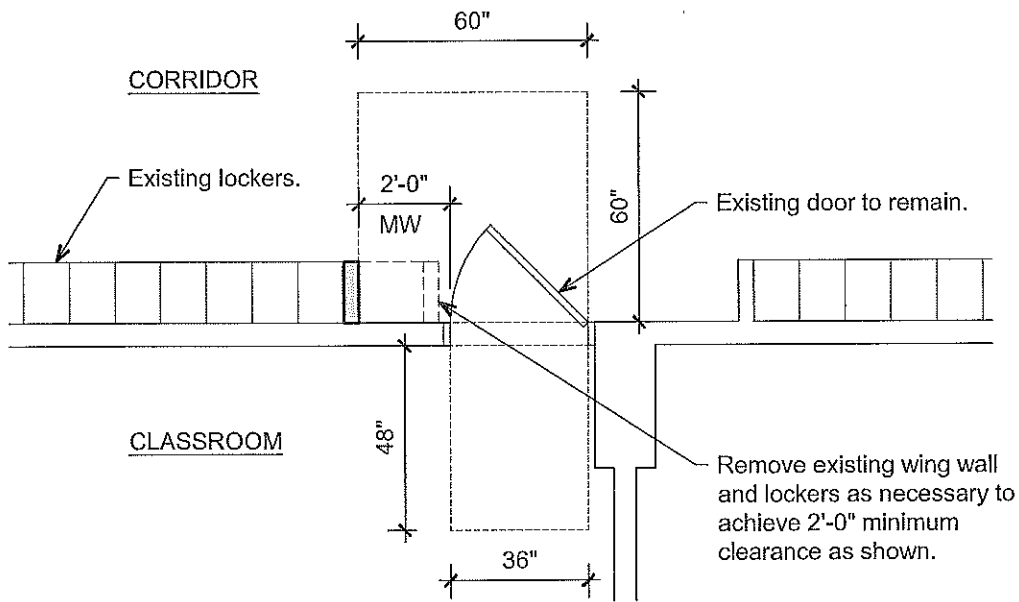

CLASSROOM ENTRY OPTION 1

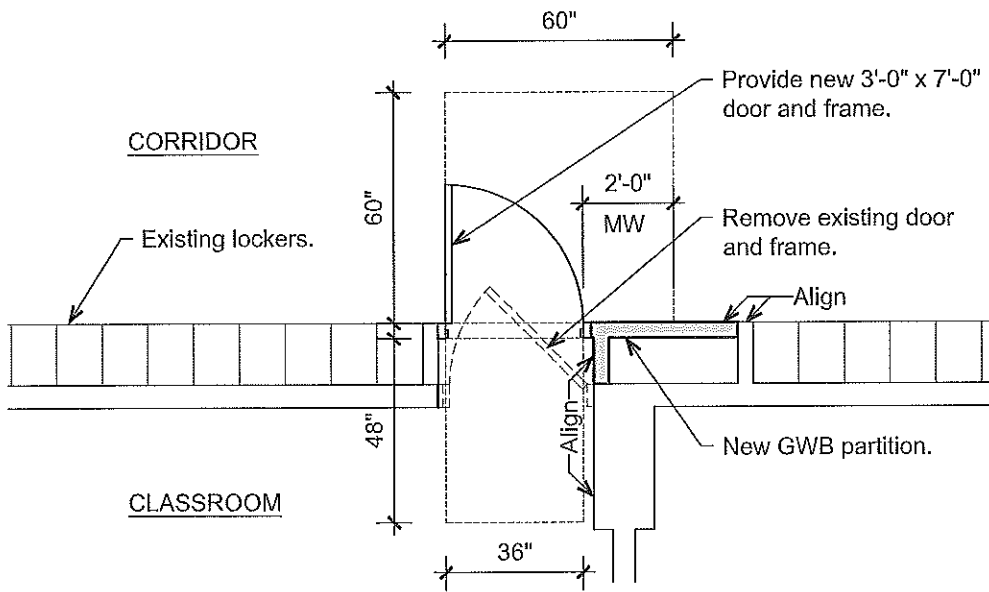

CLASSROOM ENTRY OPTION 2

EFHS - CLASSROOM DOOR SWING	MDG - 2010.034 12/9/2010
TOWN OF ENFIELD - ADA COMPLIANCE PLAN	14

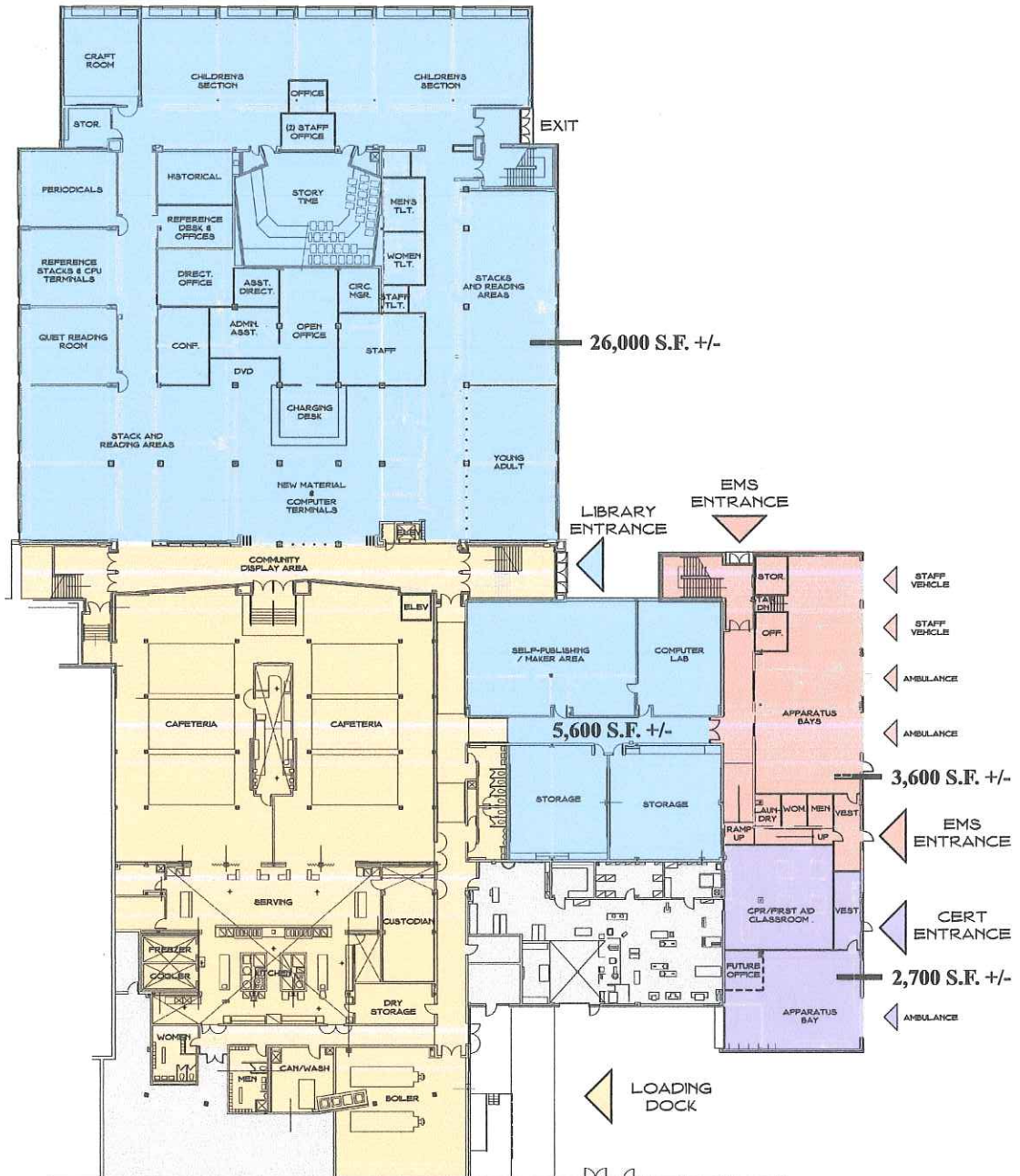

- ENFIELD PUBLIC LIBRARY and E-TV
- RECREATION DEPARTMENT
- EMERGENCY MEDICAL SERVICES (EMS)
- COMMUNITY EMERGENCY RESPONSE TEAM (CERT)
- SHARED or COMMON
- UN-USED or STORAGE



SILVER/PETRUCELLI + ASSOCIATES
 Architects Engineers Interior Designers
 3190 Whitney Avenue, Hamden, CT 06518
 Tel: 203 230 9007 Fax: 203 230 8247
 www.silverpetrucci.com

PROPOSED LOWER LEVEL PLAN - OPTION 02 (REVISED)

ENRICO FERMI HIGH SCHOOL RE-USE STUDY - 03.08.13

SCALE: 1/16" = 1'-0"

- ENFIELD PUBLIC LIBRARY and E-TV
- RECREATION DEPARTMENT
- EMERGENCY MEDICAL SERVICES (EMS)
- COMMUNITY EMERGENCY RESPONSE TEAM (CERT)
- SHARED or COMMON
- UN-USED or STORAGE

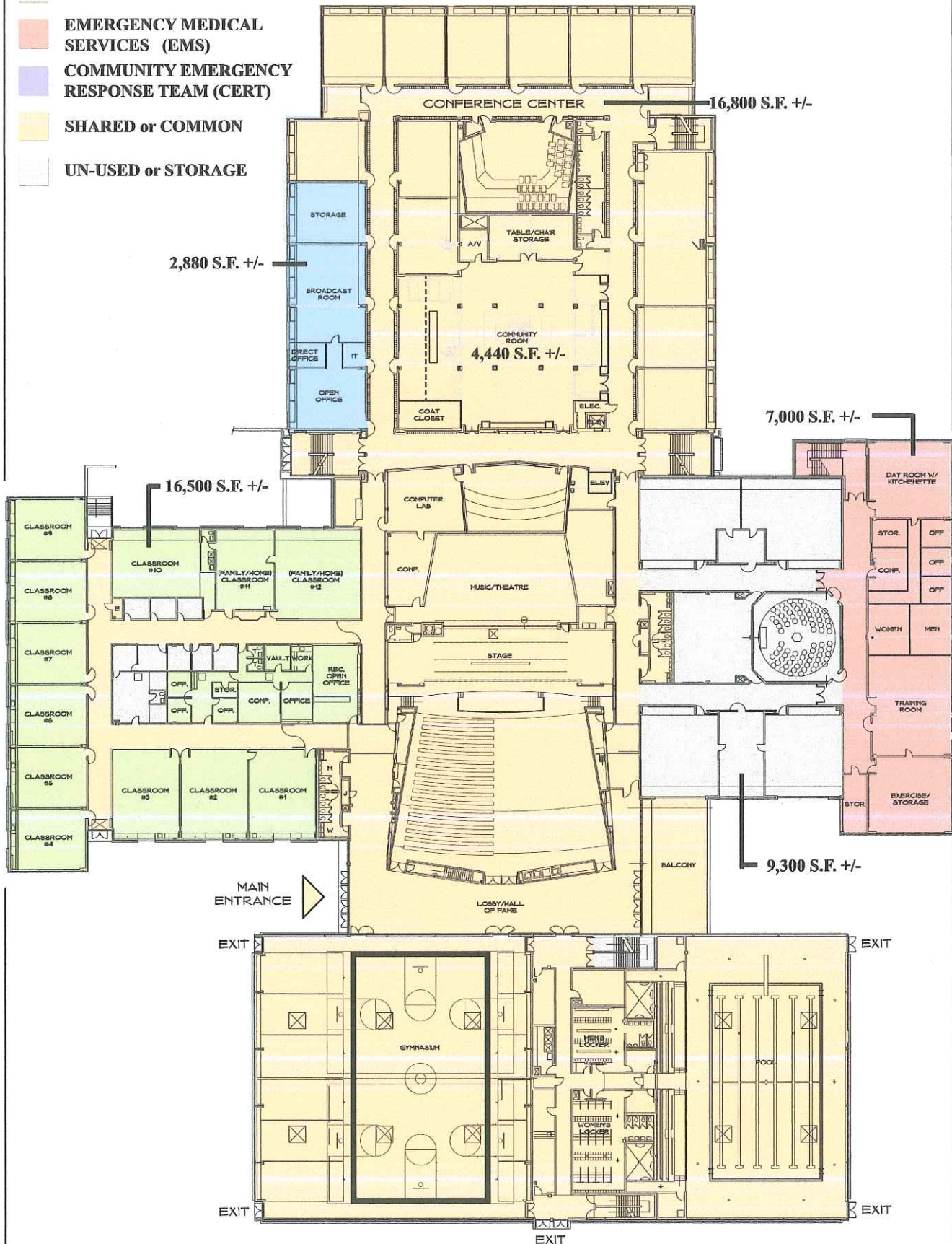

SILVER/PETRUCELLI + ASSOCIATES
 Architects • Engineers • Interior Designers
 3190 Whitney Avenue, Hamden, CT 06518
 Tel: 203 230 9007 Fax: 203 230 8247
 www.silverpetrucci.com

PROPOSED MAIN LEVEL PLAN - OPTION 02 (REVISED)
ENRICO FERMI HIGH SCHOOL RE-USE STUDY - 03.08.13
SCALE: 1/16" = 1'-0"

- ENFIELD PUBLIC LIBRARY and E-TV
- RECREATION DEPARTMENT
- EMERGENCY MEDICAL SERVICES (EMS)
- COMMUNITY EMERGENCY RESPONSE TEAM (CERT)
- SHARED or COMMON
- UN-USED or STORAGE

26,000 S.F. +/-

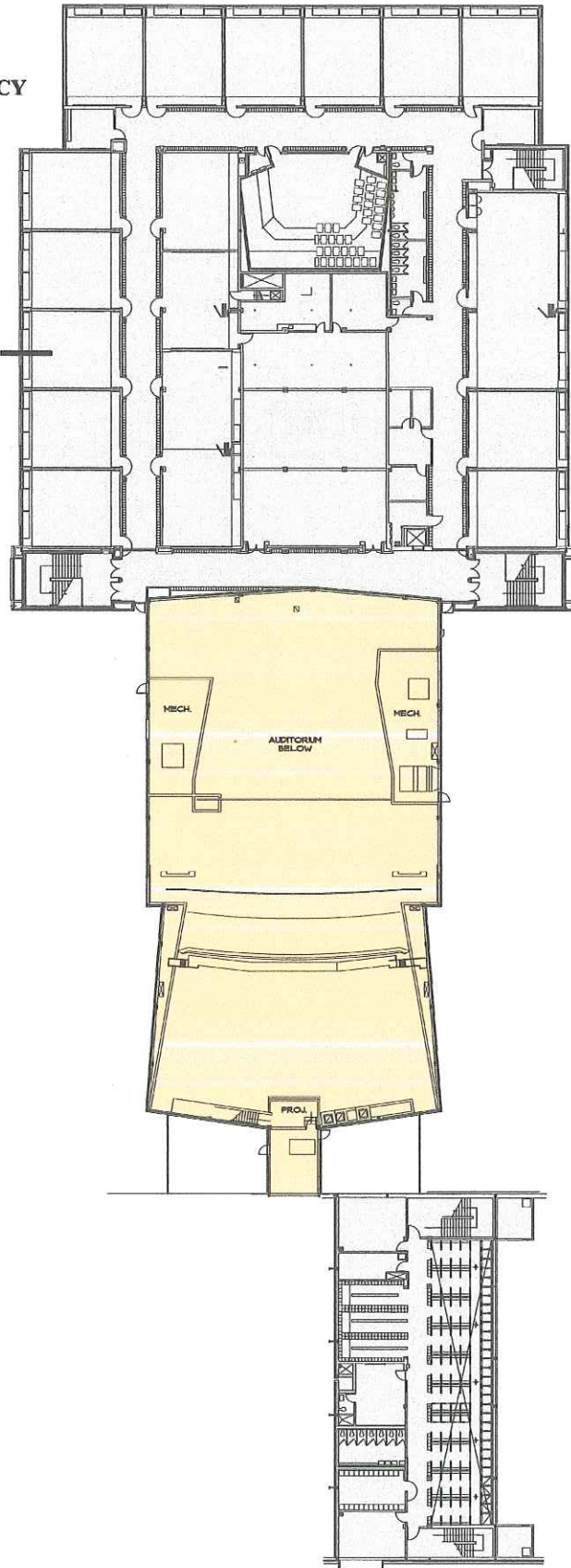

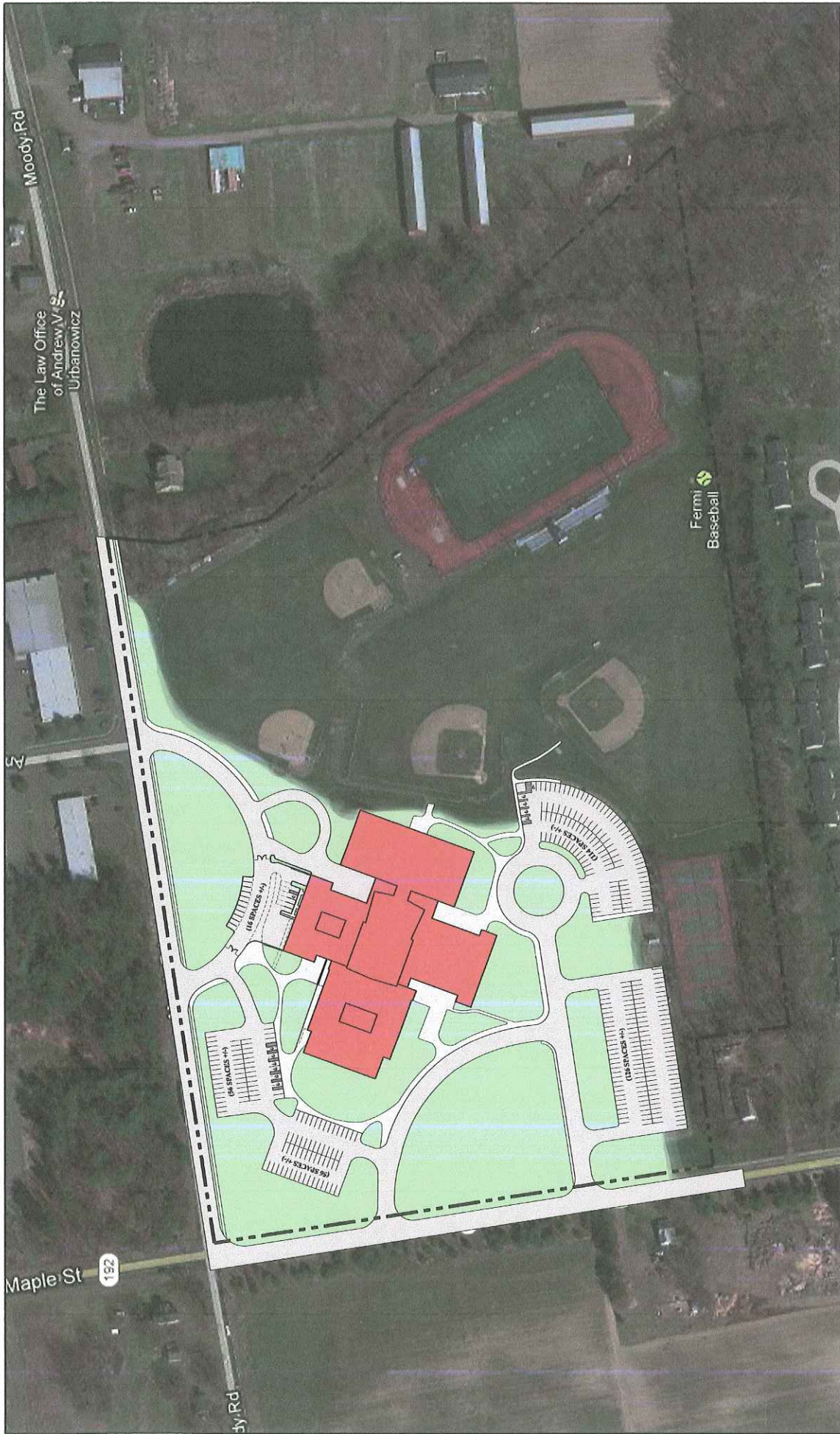

PROPOSED SITE PLAN - OVERALL
ENRICO FERMI HIGH SCHOOL RE-USE STUDY - 03.08.13
SCALE : 1" = 80'

SILVER/PETRUCELLI + ASSOCIATES
Architects Engineers Interior Designers
 3190 Whitney Avenue, Hamden, CT 06518
 Tel: 203 230 9007 Fax: 203 230 8247
www.silverpetrucelli.com





PROPOSED SITE PLAN - ENLARGED PLAN OF NORTH LOTS

ENRICO FERMI HIGH SCHOOL RE-USE STUDY - 03.08.13

SCALE : 1" = 20'

SILVER/PETRUCELLI + ASSOCIATES
architects Engineers Interior Designers

3190 Whitney Avenue, Hamden, CT 06518
 Tel: 203 230 9007 Fax: 203 230 8247

www.silverpetrucci.com



**BOARD OF EDUCATION
REGULAR MEETING MINUTES
MAY 14, 2013**

A regular meeting of the Enfield Board of Education was held at Town Hall in Council Chambers, located at 820 Enfield Street, Enfield, CT on May 14, 2013.

1. **CALL TO ORDER:** The meeting was called to order at 7:00 PM by Chairman Neville.
2. **INVOCATION OR MOMENT OF SILENCE:** Tina LeBlanc
3. **PLEDGE OF ALLEGIANCE:** Tina LeBlanc
4. **FIRE EVACUATION ANNOUNCEMENT:** Chairman Neville announced the fire evacuation announcement.
5. **ROLL CALL:**

MEMBERS PRESENT: Peter Jonaitis, Tina LeBlanc, Kevin Fealy, Vin Grady, Donna Szewczak, Joyce Hall, Tom Sirard, Jen Rancourt and Timothy Neville

MEMBERS ABSENT: None

ALSO PRESENT: Dr. Jeffrey Schumann, Superintendent and Mr. Christopher Drezek, Deputy Superintendent

6. **BOARD GUEST(S)**

- a. Special Student Recognition

Dr. Schumann stated tonight we Enrico Fermi High School Principal Mr. Paul Newton and the Board will recognize one of FHS students that received a scholarship from the Moose Club and competed in a National Competition. Mr. Newton distributed some brochures from the Moose Club.

Ms. Lauren Pierce stated she is a sophomore at Enrico Fermi High School. She competed in Chicago for a \$12,000 scholarship which unfortunately, she did not win. She won the Connecticut Scholarship for \$1,000. It was an outstanding opportunity and she learned a lot from the competition.

Mr. Newton stated it is truly an educational program where students are educating other students. Ms. Pierce represented Connecticut and Enfield and we are extremely proud of her accomplishments.

Chairman Neville, Vice Chairman Grady and Secretary Szewczak presented Ms. Pierce with a certificate acknowledging her accomplishments. Board members congratulated Ms. Pierce.

7. **SUPERINTENDENT'S REPORT**

- a. NHS Recognition Dinner – June 11th – as presented
- b. Memorial Day – Schools Closed – as presented

8. **AUDIENCES** - None

9. UNFINISHED BUSINESS

a. Continue FY2013-14 budget Discussion

Chairman Neville stated he attended the TC Budget deliberations last week. They plan to honor our request above what the Town Manager has recommended for our budget. Our request is for a \$1.5 million dollar increase. They have consented to give us a \$750K increase. They have asked if we can implement full day kindergarten with this additional amount. He has asked Dr. Schumann to put together some figures including this additional money for the Board to review. They are looking for a general consensus from the Board regarding implementing full day Kindergarten. They would also like to know if the Board would be comfortable with the \$750K coming from the Town's side of the budget and applying it to the Board's IT line item. Chairman Neville reminded the Board that this is how we did this last year. Chairman Neville told the TC that he would bring both questions to the Board for their consideration. He is in favoring of both items. Dr. Schumann will review the budget items with Board members. He will then look for a consensus by a show of hands regarding the two items.

Mr. Jonaitis stated the TC will give us funds for us to use to implement full day Kindergarten? Chairman Neville stated they added \$750K to the amount that will be given to us for the education budget. They asked the Board if we were given the extra funds, could we implement all day Kindergarten. He told them that he would support this but the entire Board would need to approve this.

Mr. Jonaitis stated they are interfering with Board decisions by giving us this money. Chairman Neville stated it is up to the Board to decide how to use the money. Mr. Jonaitis does not believe the Town Council should have made that remark.

Mr. Fealy stated this is something he had previously asked to be a line item in our budget. He supports this additional funding for the implementation of full day Kindergarten regardless if as mentioned by Mr. Jonaitis that the TC overstepped their boundaries or not.

Chairman Neville stated we are just looking for the will of the Board regarding supporting full day Kindergarten. Mr. Fealy asked if he sees any reasons why we would not be able to do this or any obstructions doing this? Chairman Neville does not see any obstructions with this.

Mr. Sirard would like to hear from Dr. Schumann before we continue this discussion.

Dr. Schumann stated that he along with Mr. Drezek met with the Town Manager and Chief Technology Officer and wanted to be absolutely sure of the allocations would be. We looked at our budget and reworked some line items. We then met with the high school principals and reviewed the scheduling process and needs. We then met with the cabinet members and looked at the entire budget. After going through everything, he believes we can provide the resources to implement full day Kindergarten. There will still be some position reductions which will lead to higher class sizes and reduction of services at the high school level. Some of the data will not be complete until we start the new school year. We are expecting to reduce between 10-15 positions. Three (3) will be in the special education para positions, 10-12 positions will be certified staff positions. We are trying to redirect some of those reductions by looking at the areas of retirements. We believe 1/3 of the positions will be in this area. The other 2/3 will need to come from layoffs and non tenured staff.

Dr. Schumann stated we have some unknowns regarding sped costs and magnet costs. We are looking for other areas for reductions. We started the work today with SEED. The expectations with this are huge.

Dr. Schumann believes we can implement full day Kindergarten with increased class sizes at the high schools.

Mr. Jonaitis asked why should we have full day Kindergarten if we need to layoff 10-15 teachers. We are basically saying the retired teacher's positions do not matter. Having full day Kindergarten is not worth it if our class sizes will increase. We were discussing cutting a team at JFK. Dr. Schumann stated that is not correct. We have decided against cutting a team at JFK. We are looking at cuts at the high schools.

Mr. Jonaitis stated we may be doing something good for these young children but the larger class sizes and reductions in-services will hurt us in the long end. He will not support this.

Mrs. LeBlanc stated if we did not support full day Kindergarten, how many positions would we be able to save with this money? Would we basically break even? Dr. Schumann stated we are reallocating 5 staff and would need 3 new positions for full day Kindergarten or 8 positions. If we did not add full day Kindergarten we would save 5 positions at the high school or at the elementary schools. We would still be increasing class sizes and the reduction of academic interventions.

Mrs. LeBlanc asked if it is legal for the TC to tell how to use the money? Chairman Neville stated that is not what they said. They asked him a question. If you have the additional funding, will you be able to implement full day Kindergarten. Is this the will of the Board? This is the decision of the Board.

Mr. Jonaitis stated if we don't do this, does this mean we will not get the money? Chairman Neville stated that is not how he understood it. They voted to give us an additional \$750K and approved it.

Mr. Fealy stated he would like to see the proposed class sizes before we layoff any staff. He would also like to see the Board look at line items for CABE membership for \$20K and Board travel for \$5K. He would like to us to use this money towards a para professional position. He cannot support a budget if we are going to layoff staff and would like clarity on this.

Dr. Schumann stated he only looked in the area of personnel. It would be the will of the Board to look in other areas for savings. Mr. Fealy would like Dr. Schumann to make these recommendations to the Board. Dr. Schumann stated this is an area for the Board to look at. We looked at high school class sizes while maintaining AP classes. We are looking at areas where sections can be consolidated. He is not sure what the class sizes will look like.

Mr. Fealy stated we are making decisions to reduce class sizes without knowing what the membership will be for each class. Dr. Schumann stated we have clarity for the elementary schools and middle schools. The high school class sizes are a bit more difficult. We are making decisions by utilizing available staff and will make adjustments based on class enrollments.

Mr. Fealy asked if the cuts will be made at the Junior and Senior levels or will they be made at the Freshman and Sophomore levels? Dr. Schumann stated we would not want large class sizes for our Freshman and Sophomore students. He is looking at the areas with higher motivated students in the Junior and Senior levels. The principals will help us with these decisions.

Mrs. Szewczak stated we have closed 2 elementary schools and made many efficiencies. We have been able to add programs even though our budget has demands. She knows the reorganization has given families some concerns. Implementing full day Kindergarten will show the community that we are committed with the consolidation of the high schools. The TC

has listened to the community and we need to make a commitment and implement full day Kindergarten. We need to form a partnership with the TC if monies are available the commitment is here.

Mr. Sirard stated we have discussed all day Kindergarten for several years and have discussed bringing programs back with the reorganization and high school consolidation. Full day Kindergarten is a priority. The TC has listened to us. The Town wants full day Kindergarten. We as the Board have an obligation to do this. This should be a priority. If we do not implement full day Kindergarten it will look as a budgetary game. He does not want to see class sizes increases. He believes the increase at the high school level will not go up more than 2-5 in classes but not across the Board. It would be disingenuous for us if we do not implement full day Kindergarten.

Ms. Hall stated full day Kindergarten is critical due to CCSS. This requires a broader Kindergarten curriculum. They are expected to know how to read by the time they leave Kindergarten so by grade 3 they are reading to learn.

Ms. Hall stated at our last Curriculum meeting we discussed class sizes doubling per the teachers requests to have 1 class of 26 at the high school instead of 2 classes of 13 for Writing and the Media class. They are looking at this for the 2013-14 school year. Students will develop a school news paper. The Curriculum committee has endorsed this change. As mentioned by Mr. Sirard the increases at the high school level will increase by 2-5 students. Once we have a budget, they can start to schedule the classes. Class sizes cannot be defined at the high school for that reason.

Mr. Grady is encouraged that the TC is giving us more funding and that we may be able to implement full day Kindergarten. This has never been an attainable goal before. He will support this initiative.

Chairman Neville stated that by attending the TC budget meetings he has increased his respect for the Town Council and what they do for our entire Town. The recognized our needs for the full day Kindergarten. This is important to all of us. He does not like to see any cuts made to the budget. Mr. Drezek has done a great job with the budget. We have taken some large hits over the past few years. Any increases at JFK would have been intolerable. We asked the TC to help us and they did. The parents asked us to do this. This is the right thing to do.

Mr. Jonaitis stated we are looking at cutting some classes at the high school in order to have full day Kindergarten. Maybe some of these classes are not needed anymore. Both high schools have accreditation concerns. He is not saying that full day Kindergarten will not help. There will be costs for security and the new teacher evaluation program. What is going to happen when we cannot afford these programs? Cuts will need to be made. Teachers need to be able to teach. We need to slow down and look at what is going on in Enfield and not what is going on in our DRG. Have we done any studies to see the value of full day Kindergarten? Have we done any studies regarding the value of Head Start? He knows these programs are valuable. He does not want to see any teaching positions cut in order to have these programs.

Mr. Jonaitis added that not every student will go to college. We need an alternative program and a vocational program. Some students are bored. We all receive our suspension reports. These kids need help. We have our expulsion program. We need to help all of our kids not just the Kindergarten students. More teachers in the classroom is better for the students. The students in the expulsion program are doing well because of the lower numbers. We need an alternative education program before we have full day Kindergarten.

Mr. Sirard stated education is changing. We cannot segregate students anymore. He has never had a problem working with the Town Council to fund education and 62% of their budget

goes to education. You cannot say that about the State. Our grants have been reduced drastically. The State has cut our funding and this is why we are having problems with our education. The Town Council is working with us. We should be looking at reductions at the high schools. The numbers are declining. We are being more efficient with our money. We should be focused on the consolidation of the high schools. This is the public's money. We educate our students. All day Kindergarten will fall on our shoulders. It is hard to ask for more money every year. Our salaries increase every year. We need something in place that will make us competitive and we have an obligation to do this.

Mr. Fealy cannot control how the money is spent. He agrees with Mr. Jonaitis that we cannot support everything. He does believe that full day Kindergarten is needed and it will benefit us. We all have good ideas. The money is going to be allocated to us. An alternative education program is not in the proposal. He does not believe that we need all of the money they are talking about. He supports full day Kindergarten. The public wants this and this will make us more competitive. This can enhance the education system and he sees this as a better head start program because it integrates our students into a mainstream population as opposed to a special interest population. We all have good ideas. You want to make a difference but these differences come with price tags. He would like to look at these expenditures and would make full day Kindergarten a priority.

Mrs. LeBlanc supports full day Kindergarten. She does not like making cuts in order to have full day Kindergarten. If we keep telling our selves that making these cuts is a good idea eventually you will start to believe it even though she knows it is not true. Someone will still suffer with these cuts whether it is at the high school level or somewhere else. She may be a dreamer as stated by John Lennon.

Chairman Neville asked Board members for a show of hands for their support of full day Kindergarten. Board members agreed to support full day Kindergarten except for Mr. Jonaitis by a show of hands 8-1.

Chairman Neville stated the other question was regarding the \$750K. They will reduce our portion of the IT budget by \$750K. He asked Boar members for a show of hands supporting the TC reducing our IT budget by \$750K. This will not affect our MBR. This is how we have done this in the past. Board members agreed to support the TC using the \$750K towards our IT budget except for Mr. Jonaitis by a show of hands 9-0.

Mr. Fealy would like to discuss CAFE and BOE travel line items in order to save a position. Chairman Neville stated this can be down at our next Board meeting after we have received our budget allocation from the Town.

Mrs. Rancourt stated the Town Council will approve our budget allocation on Wednesday. She would like our budget meetings to be done as a workshop. Chairman Neville will look to use the Enfield Room.

Mrs. Szewczak stated we can also look for other potential cost savings like CAFE, any items that we can live without.

Mr. Jonaitis asked if JFK knows that they will not be losing a team? Chairman Neville stated we were looking at an amount to get us to a certain point in the budget. It is up to the Board to make any cuts. Mr. Jonaitis believes that JFK does not know that this cut will not happen.

Mr. Fealy stated that we cannot make that promise at this time. Chairman Neville agreed, it will be up to the entire Board to make any position cuts.

Mr. Jonaitis stated if we are looking for cuts, we can look at the amount of time teachers are

out of the classrooms and subs are needed. We can look at sub usage.

Mr. Sirard stated we have not voted on our budget yet and things can change. We should probably put our budget discussion on hold until we receive our allocation from the Town Council.

Mrs. Rancourt stated if the JFK teachers are concerned about their positions, they should be addressing their concerns to us. They should come here and tell us why their jobs are needed.

Chairman Neville stated we will need to discuss dates to discuss the budget.

10. NEW BUSINESS

a. Approve School Readiness Grants

Dr. Schumann stated Ms. Pam Brown is available to answer any questions regarding the School Readiness Quality Enhancement Grant and the School Readiness Grant.

Mr. Grady moved, seconded by Mr. Sirard that the Enfield Board of Education approves the School Readiness Quality Enhancement Grant and the School Readiness Grant as presented.

Ms. Brown and Ms. Gomeau are here regarding the School Readiness Quality Enhancement Grant and the School Readiness Grant which will give 27 slots for 3 and 4 year olds.

Discussion:

Ms. Hall asked if the 27 pre-school slots are for additional slots or the existing pre-school slots? Ms. Brown stated it is for what we currently have. We did increase by 12 additional pre-school slots this year. Ms. Hall added we are moving in the right direction by having the State support this.

Mr. Fealy asked how this differs from what Head Start does? Ms. Brown stated we work with Head Start. This is for a childcare program and it has a strong educational component. The program is open for 10 hours a day while the parents are at work.

Mr. Fealy asked if this is offered to everyone in Enfield or is there a criteria that must be met for those 27 pre-school slots? Ms. Brown stated it is based on income with a sliding fee scale. We have 2 different grants available for people with financial needs.

Mr. Sirard asked if there are any financial obligations for the Board by approving this. Dr. Schumann stated there are no financial obligations for the Board, just in-kind services.

Chairman Neville asked if the sliding fee scale is based on 12 months. Ms. Brown stated that is correct, it is based on the parents income. We open at 6:30 AM and close at 5:30 PM.

Mrs. Szewczak asked which building is this program run at? Ms. Brown stated at 110 High Street at the Family Resource Center.

Mr. Grady asked if these are additional seats they wouldn't have gotten from Head Start. He knows Head Start only has space available for so many students. Ms. Brown stated they are different programs and the parents felt this program would meet their needs better. The hours for the program are longer.

Mr. Jonaitis asked if this is the same program that is on South Road? Ms. Brown stated yes it is. He added that this is a phenomenal program.

Mr. Fealy stated his concern with this program helping people is admirable but he is concerned with increasing the competition with private businesses in our community. The private sector should do their own business. He is concerned when the public sector intervenes with the private sector.

Ms. Hall stated that question has come up before. There are many parents in this town that cannot find childcare because many of the private ones are full.

Mr. Jonaitis has visited ECDC on South Road. They have little babies all the way up. Ms. Brown stated we also have an afterschool program for students up to grade 5. Mr. Jonaitis added many of the workers have been teachers. We waste money on a lot of things but this is not one of them.

Mr. Fealy asked Mr. Jonaitis if he would like to fund this if it came out of our budget. Mr. Jonaitis stated he would fund this instead of full day Kindergarten.

A vote by **roll-call 8-1-0** passed Mr. Fealy in dissent.

b. Approve Adult Education Program Improvement Project Grants

Dr. Schumann stated Ms. Chapdelaine is available to address the grants for Program Improvement Projects.

Ms. Hall moved, seconded by Mr. Grady that the Enfield Board of Education approves the Program Improvement Project (PIP) Grants as presented and authorize the Superintendent to endorse both grants.

Discussion:

Ms. Chapdelaine stated she is looking for the Board's approval of two grants – Transition: Post Secondary Education and Training and Transition: Integrated Basic Education and Skills Training (I BEST). The total amount of the grants is for \$70,000. These grants will enhance student learning. We are doing this in conjunction with Asnuntuck Community College. This will provide real opportunities with this collaboration. She is looking for the support of the Board to continue this program.

Mrs. Rancourt stated she is not familiar with Adult Education. How many students are in this program? Where are you located?. Ms. Chapdelaine stated the Adult Education Program has been in existence since 1919. All towns need to offer a basic program as defined by legislation. We collaborate with Somers, Suffield and Granby. The Adult Education grant is funded by the State and local funding. We have worked with approximately 10,000 people that have not received diplomas. We offer 3 diploma programs. The GED, Credit Diplomas and the Portfolio Program. We have a counselor available as part of the program. The GED will change in 2014. We see people at ages from 26-38. Many businesses send their employees to us. We work with area businesses.

Mrs. Rancourt asked how many Enfield residents are attending the Adult Education program? Ms. Chapdelaine stated around 439 enrollments in the mandated program.

Mrs. Rancourt asked about the costs. Ms. Chapdelaine stated they are free. We will need to pay for the tests. CT stands behind the importance of education. They will receive a State of CT diploma. If they are over the age of 21 the cost of the diploma will be \$13. The online program costs will increase. She still believes we will be able to meet their needs with the new structure that will be coming.

Mr. Fealy stated he has seen your program and it has a strong value. The student is responsible for their education. It is a handup and not a handout. They are responsible for their success.

Mr. Jonaitis stated you are using certified staff, counselors and retired teachers. The staff that is there wants to help the students. If he was to implement a vocational or alternative education program, it would put you out of business.

Mr. Sirard stated you run an amazing program. There are always questions but not with your program. Ms. Chapdelaine stated she has a great dedicated staff and could not do this without them. Mr. Sirard added that you should be extremely proud of your program.

Chairman Neville agrees with Mr. Sirard, Mr. Fealy and Mr. Jonaitis. He has been working with your for a couple of decades. Your staff has worked with many people over the years and some of them have gone onto college and have been very successful. Keep up the good work and supports this.

Mr. Fealy asked about the Adult Education graduation date. Ms Chapdelaine stated it is on June 16th.

A vote by **roll-call 8-1-0** passed Mrs. Rancourt in dissent.

Chairman Neville thanked Ms. Chapdelaine for everything she does.

11. BOARD COMMITTEE REPORTS

Ms. Hall stated the Curriculum Committee met and they discussed modified classes with the two high school principals. This is something that will stop. Our students with learning difficulties will be disbursed into more classes. The Writing and Media Class was discussed as she mentioned before. We also discussed a grade 9 academy and the potential for a STEAM Academy.

Mr. Jonaitis stated research work for students is taking away valuable teaching time in a classroom. Group work is an art. Teachers are there to motivate students not just to facilitate. Eliminating modified classes concerns him. Chairman Neville added times are changing. Sped students are being disbursed into more classrooms. They were addressing this at the Curriculum meeting because this is illegal. Board members are welcome to attend committee meetings.

Mr. Fealy stated Board members can attend committee meetings but can they participate at the meetings? Chairman Neville stated they cannot vote at a committee meeting. They can participate.

Mr. Fealy would like the Curriculum Committee members to require to look at the Common Core State Standard samples. He wants to see the curriculum before we implement it. This is a concern of his. He understands that he will not be able to view this digital curriculum. He wants to see it and wants the committee members to request this.

Ms. Hall stated that all of our curriculum will be available on-line. Mrs. Rancourt stated you were referring to the tests before. Mr. Fealy was referring to the lessons. Mrs. Rancourt stated we have the frame works for the curriculum. Mr. Fealy before we roll this out, he wants this available for parents to view.

Chairman Neville stated we can have Ms. McKernan attend a meeting after budget season. She

will be able to address these concerns. Send your questions to Dr. Schumann and he will give them to Ms. McKernan so she is prepared. Mr. Fealy stated he has asked her the questions and was told it could not be done.

Chairman Neville stated that was for the assessments. We will have Ms. McKernan attend an upcoming Board meeting to address your questions.

Mrs. Szewczak stated maybe we can purchase a set to be placed in the public library for public viewing. We have done this for other common core items.

Mrs. Szewczak stated the High School Building Committee has interviewed 4 Construction Managers At-Risk. This is a group of hard working individuals and they deserve to be thanked.

Mrs. Szewczak stated she has attended many of these meetings. She would like the Board to think about the year prior to us consolidating the high schools, we will have a class of students that will have been together since grade 6. She would like to keep them together in grade 9 at Fermi. Then we will move them over to EHS as a consolidated group. We also need to look at PE scheduling. This is something she has observed.

Mr. Jonaitis asked Mrs. Szewczak to repeat that again. Mrs. Szewczak stated the grade 9 students will have been together since grade 6, 7 and 8. They would then go over to the consolidated high school in grade 10 as a combined class. We might be able to have some Freshman sports. It will give a chance to do some team building.

Mr. Jonaitis stated you need two years of PE. Is there any way that if a student participates on a varsity team that would fulfill their PE requirement. Chairman Neville stated that would not be allowed under our current rules. These are questions that should be addressed. He also has some consolidation questions. This is something we should discuss.

Mrs. Szewczak agrees. We are getting closer to the high school consolidation. She also thought that we could have the grade 9 students take the health requirements freeing up the gym for renovations. She sees this as a stumbling block for scheduling. This is coming together nicely.

Chairman Neville would like to see this placed on a future agenda for discussion. We can bring the appropriate staff to address this.

Mrs. LeBlanc asked if you are looking at the current grade 6 students or the current grade 7 students. Mrs. Szewczak stated the contracts are being written for 2016. It would be for the current grade 7 students. She does not want to separate the students for one year. Bussing could be a problem. New ideas cause problems. It is something to think about. Mrs. LeBlanc agreed there is a lot to consider.

Mr. Jonaitis stated freeing up space at EHS for construction is a good idea. Students will make friends at all levels. Mrs. Szewczak added she would just like to keep them together would provide for a better education of the students.

Chairman Neville stated you have brought up some good points and we will address this at an upcoming meeting.

12. BOARD MEMBER COMMENTS

Mrs. LeBlanc attended the JFK National Honor Society Induction Ceremony. It was great to see this. The end of the school year is coming. Seniors will be graduating soon. Study well, get through your finals and be safe.

Mr. Jonaitis read a parent letter thanking Mr. Van Tassel and the JFK National Honor Society Induction. She thanked him for listening to her and making her child feel welcome.

Mr. Fealy stated there has been some attention regarding his private enterprise he is starting with a fellow Board member and a partner. This partnership has nothing to do with him being a Board member and his business will not impact him doing his job as a Board member. This business is a private enterprise for profit in the Town he lives in and raises his family in.

Mr. Fealy acknowledged his niece for collecting bottles and recyclables for Boston Strong in Central Massachusetts. If anyone would like to drop off recyclables you can drop them off at his home.

Mr. Grady attended the JFK NHS Honor Society induction of 44 students was extremely nice. EHS will hold their senior prom this week and his daughter will attend. He wished all the students good luck with their end of the year activities. A Fermi Baseball player was injured yesterday. He wished that person a quick and speedy recovery.

Mr. Sirard stated he was the emcee at the First Readers Ceremony. He commended all of the young first readers including his son for joining this group. He also acknowledged everyone involved in this program. If we continue to grow like we have, we will need to find a new location for this event. It was a packed house.

Ms. Hall stated the Board was recognized by our schools. Tonight she is acknowledged our Board Secretary with a plant. This is also honor school nurses week. Our nurses deserve to be recognized for everything they do. May is teacher appreciation month. She thanked all of our teachers for all of the good work they do.

Ms. Hall distributed a flyer to board members that have Facebook accounts. You can gain points for our schools with Box Tops each time your school is selected between now and May 26th.

Mrs. Rancourt stated Eli Whitney held a Bingo night and a buy-one get-one book fair that was a lot of fun. We held a luncheon for our teacher appreciation event last week. The grade 5 students went to JFK for a tour and they will go to Sturbridge Village for a class trip. Grade 5 parents can attend the parent orientation at JFK on May 21st and 22nd. They will also hold a mismatch day for students.

Mrs. Rancourt stated that her son will also attend the EHS Senior Prom. She is looking forward to the graduation and handing her son his diploma.

Chairman Neville congratulated the JFK NHS Students that were inducted into the honor society. It is always a nice program. He commended the students and parents that have taken Rachel's Challenge to heart. This Board has been affected so positively by Rachel's Challenge.

Chairman Neville has asked Dr. Schumann to put together some information on the future use of Fermi and to place this on the Board's agenda for a discussion. We have all received e-mails on this subject. We discuss future building uses for Fermi at our May 28th meeting and will act on this discussion in June. This will give the public time to give us input on this topic.

13. APPROVAL OF MINUTES

Mr. Grady moved, seconded by Mrs. Szewczak that the Regular Meeting minutes of April 23, 2013 be approved. A vote by **show-of-hands 9-0-0** passed unanimously.

14. APPROVAL OF ACCOUNTS PAYROLL

a. For the Month of April 2012/13

Mrs. LeBlanc moved, seconded by Mr. Grady that the Enfield Board of Education accept the superintendent's certification as follows: "I hereby certify that in the month of April, total expenditures amount to \$5,495,751.92, broken down between payroll totaling \$4,152,424.31 and other accounts totaling \$1,343,327.61. All payments have been made in accordance with the approved budget and are properly accounted for within the books of accounts. Copies of approval for check invoices are properly documented."

A vote by **show-of-hands 9-0-0** passed unanimously.

b. Line Item Transfers, if any - None

15. CORRESPONDENCE AND COMMUNICATIONS - None

16. EXECUTIVE SESSION

Mr. Grady moved, seconded by Mrs. Szewczak that the Board enters into Executive Session for:

- a. Matter(s) Related to Superintendent's Evaluation.
- b. Matter(s) Related to Collective Bargaining

A vote by **show-of-hands 7-1-0** passed with Mr. Jonaitis in dissent at 9:13 PM.

The Board reconvened to the Break Room for the Executive Session. Joining the Board in Executive Session were Dr. Schumann and Mr. Drezek.

The Executive Session ended at 10:18 PM. No Board action occurred while in Executive Session.

17. ADJOURNMENT

Mr. Grady moved, seconded by Mr. Sirard to adjourn the Regular Meeting of May 14, 2013.

All ayes, motion passed unanimously.

Meeting stood adjourned at 10:18 PM.

Donna Szewczak
Secretary
Board of Education

Respectfully Submitted,

Kathy Zalucki, Recording Secretary